

PRODUCT MONOGRAPH

Pr **XOLAIR**[®]

(omalizumab)

Sterile powder for reconstitution, 150 mg vial

Solution for injection, 75 mg and 150mg pre-filled syringe

IgE-Neutralizing Antibody (Anti-IgE)

Novartis Pharmaceuticals Canada Inc.
385 Bouchard Blvd., Dorval, Quebec
H9S 1A9

Date of Initial Authorization:
November 18, 2004

Date of Revision:
July 19, 2021

Submission Control No. 241064

XOLAIR is a registered trademark.

Table of Contents

PART I: HEALTH PROFESSIONAL INFORMATION.....	3
SUMMARY PRODUCT INFORMATION	3
INDICATIONS AND CLINICAL USE.....	3
CONTRAINDICATIONS	4
WARNINGS AND PRECAUTIONS.....	4
ADVERSE REACTIONS.....	9
DRUG INTERACTIONS	16
DOSAGE AND ADMINISTRATION.....	17
OVERDOSAGE	27
ACTION AND CLINICAL PHARMACOLOGY	28
STORAGE AND STABILITY.....	31
DOSAGE FORMS, COMPOSITION AND PACKAGING	31
PART II: SCIENTIFIC INFORMATION	33
PHARMACEUTICAL INFORMATION.....	33
CLINICAL TRIALS.....	34
DETAILED PHARMACOLOGY	50
TOXICOLOGY	51
REFERENCES	60
PART III: CONSUMER INFORMATION.....	63

Pr **XOLAIR**[®]
(omalizumab)

PART I: HEALTH PROFESSIONAL INFORMATION

SUMMARY PRODUCT INFORMATION

Route of Administration	Dosage Form / Strength	Clinically Relevant Nonmedicinal Ingredients
subcutaneous	Sterile powder for reconstitution 150 mg vial	sucrose, L-histidine hydrochloride monohydrate, L-histidine and polysorbate 20
subcutaneous	Solution for injection in pre-filled syringe (75 mg/0.5 mL and 150 mg/1.0 mL)	L-arginine hydrochloride, L-histidine hydrochloride, L-histidine, polysorbate 20, water for injection.

INDICATIONS AND CLINICAL USE

XOLAIR (omalizumab) is indicated for:

- Adult and pediatric patients (6 years of age and above) with moderate to severe persistent asthma who have a positive skin test or *in vitro* reactivity to a perennial aeroallergen and whose symptoms are inadequately controlled with inhaled corticosteroids.
 - Adults and adolescents (12 years of age and older): XOLAIR has been shown to significantly decrease the incidence of asthma exacerbations and improve control of asthma symptoms in these patients (see CLINICAL TRIALS).
 - Children (6 to <12 years of age): XOLAIR, used as add-on therapy, has been shown to significantly decrease asthma exacerbation rates in children who are inadequately controlled and have a documented history of exacerbation (see CLINICAL TRIALS).
- Add-on maintenance treatment with intranasal corticosteroids in adult patients with severe chronic rhinosinusitis with nasal polyps (CRSwNP) inadequately controlled by intranasal corticosteroids alone.
- The treatment of adults and adolescents (12 years of age and above) with chronic idiopathic urticaria (CIU) who remain symptomatic despite H1 antihistamine treatment.

The safety and efficacy of XOLAIR have not been established in other conditions.

Geriatrics (> 65 years of age): There is limited experience with XOLAIR in patients over 65

years of age (see **WARNINGS AND PRECAUTIONS, Special Populations, Geriatrics**).

Pediatrics:

- Allergic asthma: XOLAIR is not indicated for children below 6 years of age.
- Chronic rhinosinusitis with nasal polyps (CRSwNP): XOLAIR is not indicated for children below 18 years of age.
- Chronic idiopathic urticaria (CIU): XOLAIR is not indicated for children below 12 years of age.

CONTRAINDICATIONS

XOLAIR (omalizumab) should not be administered to patients with known hypersensitivity to omalizumab or any component of the formulation (see SUMMARY PRODUCT INFORMATION), or patients who have experienced a severe hypersensitivity reaction to XOLAIR (see WARNINGS AND PRECAUTIONS: Anaphylaxis).

WARNINGS AND PRECAUTIONS

Serious Warnings and Precautions

Anaphylaxis, presenting as angioedema of the throat or tongue, bronchospasm, hypotension, syncope, and/or urticaria has been reported to occur after administration of XOLAIR. Anaphylaxis has occurred as early as after the first dose of XOLAIR, but also has occurred beyond 1 year after beginning regularly administered treatment. Because of the risk of anaphylaxis, patients should be closely observed for an appropriate period of time after XOLAIR administration, and health care providers administering XOLAIR should be prepared to manage anaphylaxis that can be life-threatening. Patients should also be informed of the signs and symptoms of anaphylaxis and instructed to seek immediate medical care should symptoms occur (see WARNINGS AND PRECAUTIONS, Information for Patients).

General

XOLAIR (omalizumab) has not been shown to alleviate asthma exacerbations acutely and should not be used for the treatment of acute bronchospasm or status asthmaticus.

Anaphylaxis

Anaphylaxis has been reported to occur after administration of XOLAIR in premarketing clinical trials and in postmarketing spontaneous reports (See ADVERSE REACTIONS). Signs and symptoms in these reported cases have included angioedema of the throat or tongue, bronchospasm, hypotension, syncope, and/or urticaria. Some of these events have been life-threatening. In premarketing clinical trials the frequency of anaphylaxis attributed to XOLAIR use was estimated to be 0.1%. In post-marketing reports, the frequency of anaphylaxis in patients exposed to XOLAIR use was estimated to be 0.2% based on a total number of anaphylactic reactions observed from an estimated exposure of over 500,000 patient years. Anaphylaxis and anaphylactoid reactions have been reported following the first or subsequent administrations of

XOLAIR. Although most of these reactions occurred within 2 hours, some occurred beyond 2 hours. Anaphylaxis has occurred as early as after the first dose of XOLAIR, but also has occurred beyond one year after beginning regularly scheduled treatment.

XOLAIR should only be administered in a healthcare setting by healthcare providers prepared to manage anaphylaxis that can be life-threatening. Patients should be closely observed for an appropriate period of time after administration of XOLAIR, taking into account the time to onset of anaphylaxis seen in premarketing clinical trials and postmarketing spontaneous reports (see ADVERSE REACTIONS). Patients should be informed of the signs and symptoms of anaphylaxis, and instructed to seek immediate medical care should signs or symptoms occur (see Information for Patients).

XOLAIR should be discontinued in patients who experience a severe hypersensitivity reaction (see CONTRAINDICATIONS).

Cardiovascular and Cerebrovascular disorders

In controlled clinical trials in adults and adolescents 12 years of age and older, cerebrovascular events including transient ischaemic attack and ischaemic stroke were observed in patients treated with XOLAIR. (See ADVERSE REACTIONS).

In a 5 year observational study of adults and adolescents, a disproportionate increase of overall cardiovascular and cerebrovascular disorders was observed in the XOLAIR cohort compared to the non-XOLAIR cohort (see ADVERSE REACTIONS).

Corticosteroid Reduction

Systemic or inhaled corticosteroids should not be abruptly discontinued upon initiation of XOLAIR therapy in allergic asthma or chronic rhinosinusitis with nasal polyps (CRSwNP). Decreases in corticosteroids should be performed under the direct supervision of a physician and may need to be performed gradually.

Immune System disorders

Churg-Strauss syndrome and hypereosinophilic syndrome {wording as per SPC}

Patients with severe asthma may rarely present systemic hypereosinophilic syndrome or allergic eosinophilic granulomatous vasculitis (Churg-Strauss syndrome), both of which are usually treated with systemic corticosteroids. In rare cases, patients on therapy with anti-asthma agents, including omalizumab, may present or develop systemic eosinophilia and vasculitis. These events are commonly associated with the reduction of oral corticosteroid therapy. In these patients, physicians should be alert to the development of marked eosinophilia, vasculitic rash, worsening pulmonary symptoms, paranasal sinus abnormalities, cardiac complications, and/or neuropathy.

Serum sickness

Serum sickness and serum sickness-like reactions, which are delayed allergic type III reactions, have rarely been seen in patients treated with humanized monoclonal antibodies including omalizumab. The onset has typically been 1-5 days after administration of the first or subsequent injections, also after long duration of treatment. Symptoms suggestive of serum sickness include arthritis/arthralgia, rash (urticaria or other forms), fever and lymphadenopathy. Antihistamines

and corticosteroids may be useful for preventing or treating this disorder, and patients should be advised to report any suspected symptoms.

Immunogenicity

As with all DNA derived humanized monoclonal antibodies patients may rarely develop antibodies to omalizumab (See ADVERSE REACTIONS).

Discontinuation of omalizumab should be considered in all severe cases of Chrug-Strauss syndrome, hypereosinophilic syndrome and serum sickness.

Information for Patients

Patients should be advised of the risk of life-threatening anaphylaxis with XOLAIR and that there have been reports of anaphylaxis up to 4 days after administration of XOLAIR. XOLAIR should only be administered in a healthcare setting by healthcare providers. Patients should be closely observed following its administration. Patients should be informed of the signs and symptoms of anaphylaxis. Patients should be instructed to seek immediate medical care should such signs or symptoms occur (see WARNINGS AND PRECAUTIONS, Anaphylaxis).

Asthma patients receiving XOLAIR should be instructed not to decrease the dose of or stop taking any other asthma medications unless otherwise instructed by their physician. Asthma patients should be told that they may not see immediate improvement in their asthma after beginning XOLAIR therapy.

Patients receiving XOLAIR should be informed that if they experience dizziness, fatigue, syncope or somnolence, they should not drive or use machines.

Other IgE-Associated disorders

XOLAIR has not been studied in patients with hyperimmunoglobulin E syndrome, allergic bronchopulmonary aspergillosis, or for the prevention of anaphylactic reactions. XOLAIR has not been adequately studied in food allergy, atopic dermatitis, allergic rhinitis, or parasitic infestations.

Parasitic (helminth) infections

IgE may be involved in the immunological response to some helminth infections. In patients at chronic high risk of helminth infection, a placebo-controlled trial in asthma/perennial allergic rhinitis patients showed a slight increase in infection rate with omalizumab, although the course, severity, and response to treatment of infection were unaltered. The helminth infection rate in the overall clinical program, which was not designed to detect such infections, was less than 1 in 1,000 patients. However, caution may be warranted in patients at high risk of helminth infection, in particular when travelling to areas where helminthic infections are endemic. If patients do not respond to recommended anti-helminth treatment, discontinuation of XOLAIR should be considered.

Pre-filled syringe, latex-sensitive individuals

The removable needle cap of XOLAIR solution for injection in pre-filled syringe contains a derivative of natural rubber latex. Although no natural rubber latex is detected in the removable needle cap, the safe use of XOLAIR solution for injection in pre-filled syringe in latex-sensitive individuals has not been studied.

Renal or Hepatic impairment

XOLAIR therapy has not been studied in patients with pre-existing renal or hepatic impairment. Caution should be exercised when administering XOLAIR in these patient populations.

Special Populations

Pregnant Women:

There are no well-controlled clinical studies of XOLAIR in pregnant women. A prospective pregnancy registry study (EXPECT) conducted in the US from 2006 to 2018, included 250 pregnant women with asthma treated with XOLAIR. 246 of the women were exposed to XOLAIR in the first trimester of pregnancy and 78.4% (196/250) of the women were exposed to XOLAIR at least once during all 3 trimesters of pregnancy with an overall median exposure duration of 8.7 months. The EXPECT findings for relevant mother and infant subgroups were compared to age-adjusted frequencies in a disease matched external cohort of 1,153 pregnant women with moderate and severe asthma (without exposure to XOLAIR) identified from healthcare databases of Quebec, and termed the Quebec External Comparator Cohort (QECC). Among EXPECT infants used for comparison to QECC (n=223), the prevalence of major congenital anomalies (8.1%) was similar to that for QECC infants (8.9%). There was an increased rate of low birth weight among registry infants compared to infants in the other cohort. This study cannot definitively establish the absence of increased risks, because of methodological limitations, including small sample size, a nonrandomized study design and differences between the registry population and the comparator group.

IgG molecules are known to cross the placental barrier. Reproduction studies in cynomolgus monkeys have been conducted with omalizumab. Subcutaneous doses up to 75 mg/kg per week (approximately 10-fold the highest recommended clinical dose in mg/kg over a 4-week period) of omalizumab did not elicit maternal toxicity, embryotoxicity, or teratogenicity when administered throughout organogenesis and did not elicit adverse effects on fetal or neonatal growth when administered throughout late gestation, delivery, and nursing.

As the EXPECT study cannot definitively establish the absence of increased risks and animal reproduction studies are not always predictive of human response, XOLAIR should be used during pregnancy only if clearly needed.

Nursing Women:

While XOLAIR presence in human milk has not been studied, IgGs are present in human milk and therefore it is expected that XOLAIR will be present in human milk. The majority of infants (77.5%, 186/240) in the EXPECT pregnancy exposure registry were breastfed. Serious adverse

events categorized as “infections and infestations” were not increased in infants who were exposed to XOLAIR through breastfeeding compared with infants who were not breastfed, or infants who were breastfed without exposure to XOLAIR. The interpretation of data may be impacted due to methodological limitations of the study, including small sample size and nonrandomized design. The potential for XOLAIR absorption or harm to the infant are unknown; caution should be exercised when administering XOLAIR to a nursing woman.

The excretion of omalizumab in milk was evaluated in female cynomolgus monkeys receiving SC doses of 75 mg/kg/week. Neonatal serum levels of omalizumab after *in utero* exposure and 28 days of nursing were between 11% and 94% of the maternal serum level. Milk levels of omalizumab were 0.15% of the maternal serum concentration.

Although no clinically significant effects on platelets have been observed in patients, doses of omalizumab in excess of the clinical dose have been associated with age-dependent decreases in blood platelets in non-human primates, with a greater relative sensitivity in juvenile animals. In reproduction studies in cynomolgus monkeys, there was no clinical evidence of thrombocytopenia in neonatal monkeys from mothers treated up to 75 mg/kg omalizumab; however, platelet counts were not measured in these offspring.

Fertility:

There are no human fertility data for omalizumab. In specifically-designed non clinical fertility studies in adult cynomolgus monkeys, including mating studies, no impairment of male or female fertility was observed following repeated dosing with omalizumab at dose levels up to 75 mg/kg.

Pediatrics:

Asthma

Safety and efficacy of XOLAIR for asthma were evaluated in 2 trials in 926 (XOLAIR 624; placebo 302) pediatric patients 6 to <12 years of age with moderate to severe persistent asthma who had a positive skin test or *in vitro* reactivity to a perennial aeroallergen. One trial was a pivotal trial of similar design and conduct to that of adult and adolescent Asthma Trials 1 and 2. The other trial was primarily a safety study and included evaluation of efficacy as a secondary outcome (See ADVERSE REACTIONS and CLINICAL TRIALS).

The safety and efficacy of XOLAIR in children below the age of 6 have not been established and use of XOLAIR in such patients is therefore not recommended.

Chronic Rhinosinusitis with Nasal Polyps (CRSwNP)

In CRSwNP, safety and efficacy in patients below the age of 18 years have not been established.

Chronic Idiopathic Urticaria (CIU)

The safety and efficacy of XOLAIR in children below the age of 12 have not been established and use of XOLAIR in such patients is therefore not recommended.

Geriatrics (> 65 years of age):

In Phase III clinical trials, 145 asthma patients and 37 CIU patients, 65 years of age or older were treated with XOLAIR. Although there were no apparent age-related differences observed in these studies, the number of patients aged 65 and over is not sufficient to determine whether they respond differently from younger patients.

Monitoring and Laboratory Tests

Serum total IgE levels increase following administration of XOLAIR due to formation of omalizumab:IgE complexes (See ACTION AND CLINICAL PHARMACOLOGY and DOSAGE AND ADMINISTRATION). Elevated serum total IgE levels may persist for up to 1 year following discontinuation of XOLAIR. Serum total IgE levels obtained less than 1 year following discontinuation may not reflect steady state free IgE levels and should not be used to reassess the dosing regimen in asthma patients.

ADVERSE REACTIONS

Clinical trials are conducted under very specific conditions. The adverse reaction rates observed in the clinical trials; therefore, may not reflect the rates observed in practice and should not be compared to the rates in the clinical trials of another drug. Adverse reaction information from clinical trials may be useful for identifying and approximating rates of adverse drug reactions in real-world use.

Asthma

Adverse Drug Reaction Overview

The adverse reactions most commonly observed among patients treated with XOLAIR (omalizumab) in pre-marketing clinical studies included injection site reaction (45%), viral infections (24%), upper respiratory tract infection (19%), sinusitis (16%), headache (15%), and pharyngitis (10%). These events were observed at similar rates in XOLAIR-treated patients and control patients.

The occurrence of adverse events resulting in clinical intervention (e.g. discontinuation of XOLAIR, or the need for concomitant medication to treat an adverse reaction) was extremely small; 0.1 % or less.

The data described above reflect XOLAIR exposure for 2285 adult and adolescent patients ages 12 and older, including 1891 patients exposed for six months and 555 exposed for one year or more, in either placebo-controlled or other controlled asthma studies. The mean age of patients receiving XOLAIR was 41 years, 59% were women, and 86% Caucasian. Patients received XOLAIR 150 to 375 mg every 2 or 4 weeks or, for patients assigned to control groups, standard therapy with or without a placebo.

The frequency of adverse events was comparable between the XOLAIR and placebo groups (85.1% vs. 84.0%, respectively). The majority of these adverse events were regarded as mild or moderate in intensity. Treatment discontinuation due to an adverse event occurred more frequently in the placebo group compared with the XOLAIR-treated group (1.4% vs. 0.5%, respectively).

The table below shows adverse events that occurred $\geq 1\%$ more frequently in adult and adolescent patients 12 years of age and older receiving XOLAIR than in those receiving placebo in the placebo controlled asthma studies. Adverse events were classified using preferred terms from the International Medical Nomenclature (IMN) dictionary. Injection site reactions were recorded separately from the reporting of other adverse events and are described following the table.

Clinical Trial Adverse Drug Reactions

Table 1 - All Adverse Events Occurring $\geq 1\%$ More Frequently in XOLAIR-Treated Asthma Patients 12 to 75 years of Age Compared with Placebo, Regardless of Causality Assessment.

Adverse Event	XOLAIR (n=947) Number (%) of Patients Reporting the Event	Placebo (n=913) Number (%) of Patients Reporting the Event
Any Adverse Event	806 (85.1)	767 (84.0)
Body as a whole		
Pain	51 (5.4)	40 (4.4)
Musculoskeletal system		
Fracture	20 (2.1)	10 (1.1)
Leg pain	26 (2.7)	14 (1.5)
Nervous system		
Dizziness	24 (2.5)	15 (1.5)

Injection Site Reactions

In the adult and adolescent (≥ 12 years of age) population, injection site reactions of any severity occurred at a rate of 45% in XOLAIR-treated patients compared with 43% in placebo-treated patients. The types of injection site reactions included: bruising, redness, warmth, burning, stinging, itching, hive formation, pain, indurations, mass, and inflammation. Most were regarded as mild or moderate in intensity and did not require discontinuation of therapy. Severe injection site reactions occurred more frequently in XOLAIR treated patients compared with patients in the placebo group (12% versus 9%).

The majority of injection site reactions occurred within 1 hour post injection, lasted less than 8 days, and generally decreased in frequency at subsequent dosing visits.

Adverse Reactions from Clinical Studies in Pediatric Patients 6 to <12 Years of Age with Asthma

The incidence of adverse reactions in pediatric patients 6 to <12 years of age is based on 2 double-blind, placebo-controlled studies in asthma. Of the 926 pediatric patients evaluated, 624 received XOLAIR (583 pediatric patients exposed for six months and 292 exposed for one year or more). The mean age of pediatric patients receiving XOLAIR was 8.8 years; 69% were male, and 64% were Caucasian. Pediatric patients received XOLAIR 75 mg to 375 mg every 2 or 4

weeks, or for patients assigned to control groups, standard therapy with or without a placebo. The frequency of adverse events in the XOLAIR and placebo groups was 89.7% vs 91.7%, respectively. The most common adverse reactions occurring at $\geq 3\%$ in the pediatric patients receiving XOLAIR and more frequently than in patients treated with placebo were nasopharyngitis (23.6% vs 23.2%), headache (20.7% vs 19.5%), pyrexia (15.1% vs 11.3%), upper abdominal pain (6.3% vs 5.0%), pharyngitis streptococcal (6.1% vs 5.3%), otitis media (5.8% vs 5.3%), viral gastroenteritis (3.8% vs 2.3%), epistaxis (3.4% vs 3.3%) and arthropod bite (3.2% vs 0.7%). Other adverse events that were reported less frequently, but at least $\geq 1\%$ more frequently in the XOLAIR-treated patients compared to placebo include stomach discomfort (2.2% vs 1%), gastritis (1.6% vs 0%), eczema (1.8% vs 0.7%) and herpes zoster (1% vs 0%). There were 3 patients (0.5%) who discontinued XOLAIR due to adverse events (1 event each of bronchitis, headache and urticaria).

Less Common Clinical Trial Adverse Drug Reactions (<1%)

Allergic Events

As with any protein, local or systemic allergic reactions can occur (See WARNINGS AND PRECAUTIONS). Anti-therapeutic antibody development and allergic symptoms, including urticaria, dermatitis, and pruritus were observed in patients treated with XOLAIR. In the adult and adolescent (≥ 12 years of age) population, there were 3 cases out of 3854 (0.08%) of anaphylaxis observed within 2 hours of XOLAIR administration in which there were no other identifiable allergic triggers. Anaphylaxis occurred with the first dose of XOLAIR in two patients, and with the fourth dose in one patient. The time to onset of anaphylaxis was 90 minutes after administration in two patients and 2 hours after administration in one patient. These events included urticaria and throat and/or tongue edema. Anaphylaxis/anaphylactoid reaction was reported in 1 of 2215 (0.05%) control patients.

Immunogenicity

In clinical studies of adult and adolescent patients (≥ 12 years of age), antibodies to XOLAIR were detected in 1 out of 1723 patients. In three clinical studies of pediatric patients 6 to <12 years of age, antibodies to XOLAIR were detected in 1 out of 581 patients.

Cardiovascular and Cerebrovascular events

During interim analysis of an observational study in adolescent and adult patients, an imbalance of cardiovascular and cerebrovascular serious adverse events was observed in the XOLAIR group compared to the non-XOLAIR group. The final analysis of the results of the observational study showed the rate of cardiovascular and cerebrovascular events per 1000 patient years was 17.34 (265/15286 patient years) for XOLAIR-treated patients and 11.44 (114/9963) for control patients. The Cox proportional hazards models adjusting for confounders and risk factors resulted in a hazard ratio of 1.62 (95% [1.23-2.13]). Cardiovascular and cerebrovascular events in which increases in rates were observed include myocardial infarction, unstable angina, transient ischemic attack, pulmonary embolism, and venous thrombosis.

The rate of arterial thromboembolic events (ATEs) in the observational study per 1000 patient years was 7.52 (115/15286 patients years) for XOLAIR-treated patients and 5.12 (51/9963 patient years) for control patients. The Cox proportional hazards models adjusting for confounders and risk factors resulted in a hazard ratio of 1.32 (95%, [0.91, 1.91]). In a separate

analysis of randomized, double-blind, placebo-controlled clinical trials of 8 or more weeks duration in adolescent and adult patients, including 3342 patients on XOLAIR and 2895 patients on placebo, the rate of ATE per 1000 patient years was 2.69 (5/1856 patients years) for XOLAIR-treated patients and 2.38 (4/1680 patient years) for placebo patients (rate ratio 1.13, 95%, [0.24-5.71]). The observed incidence rate of arterial thromboembolic events in the XOLAIR controlled clinical trials was comparable to that reported in the general asthma population.

Malignancies

During initial clinical trials for adults and adolescents 12 years of age and older, there was a numerical imbalance in malignancies arising in the active treatment group, compared with the control group. The number of observed cases was uncommon (<1/100) in both the active and the control group. Malignant neoplasms were observed in 25 of 5015 (0.5%) XOLAIR-treated patients compared with 5 of 2854 (0.2%) control patients in clinical studies of asthma and other allergic disorders. The observed malignancies in XOLAIR-treated patients were a variety of types, with breast, non-melanoma skin, prostate, melanoma, and parotid occurring more than once, and five other types occurring once each. The diversity in the type of cancers observed, the relatively short duration of exposure and the clinical features of the individual cases render a causal relationship unlikely.

In a subsequent observational study comparing 5007 XOLAIR -treated and 2829 non-XOLAIR-treated adolescent and adult patients followed for up to 5 years, the incidence rates of primary malignancies per 1000 patient years were 16.01 (295/18426 patient years) and 19.07 (190/9963 patients years), respectively, which does not indicate an increased malignancy risk (rate ratio 0.84, 95% confidence interval, 0.62-1.13).

In a further analysis of randomized, double-blind, placebo-controlled clinical trials in adolescent and adult patients, including 4254 patients on XOLAIR and 3178 patients on placebo, XOLAIR treatment was not associated with an increased malignancy risk based on incidence rates per 1000 patient years of 4.14 (14/3382 patient years) for XOLAIR treated patients and 4.45 (11/2474 patient years) for placebo patients (rate ratio 0.93, 95%, [0.39-2.27]). The overall observed incidence rate of malignancy in the XOLAIR clinical trial program was comparable to that reported in the general population. The impact of longer exposure to XOLAIR or use in patients at higher risk for malignancy (elderly, current smokers) is unknown.

Chronic Rhinosinusitis with Nasal Polyps (CRSwNP)

Clinical Trial Adverse Drug Reactions

The data described below reflect pooled data from two placebo-controlled studies in patients ≥ 18 years of age (see CLINICAL TRIALS for design and patient characteristics). In these studies, patients received omalizumab 150 to 600 mg every 2 or 4 weeks according to the recommended dosing presented in Table 6, Recommended Dose for CRSwNP, or placebo. All patients received background intranasal mometasone therapy.

The pooled placebo-controlled trials included 135 patients treated with omalizumab and 130

treated with placebo for up to 24 weeks. In this safety pool, there were 50.4% of omalizumab and 58.5% of placebo patients that experienced adverse events, and 2.2% of omalizumab and 1.5% of placebo patients that experienced serious adverse events. No omalizumab-treated patients discontinued due to adverse events.

The most frequently ($\geq 1\%$) reported adverse events, which were higher in frequency in comparison to placebo are shown in Table 2.

Table 2 – Adverse events occurring in $\geq 1\%$ of omalizumab-treated patients and occurring more commonly than placebo-treated patients in the 24-week pooled Phase 3 trials

Adverse event (by MedDRA preferred term)	Nasal polyp studies POLYP 1 and POLYP 2	
	Placebo N=130	Omalizumab N=135
Gastrointestinal disorder		
Abdominal pain upper	1 (0.8%)	4 (3.0%)
Irritable bowel syndrome	0	2 (1.5%)
General disorders and administration site conditions		
Injection site reactions (Injection site reactions, Injection related reaction, injection site pain)	2 (1.5%)	7 (5.2%)
Influenza-like illness	1 (0.8%)	2 (1.5%)
Infections and infestations		
Sinusitis	3 (2.3%)	4 (3.0%)
Influenza	0	3 (2.2%)
Pharyngitis	0	2 (1.5%)
Nervous system disorders		
Headache	7 (5.4%)	11 (8.1%)
Dizziness	1 (0.8%)	4 (3.0%)
Musculoskeletal and connective tissue disorders		
Arthralgia	2 (1.5%)	4 (3.0%)
Respiratory, thoracic and mediastinal disorders		
Cough	1 (0.8%)	3 (2.2%)
Skin and subcutaneous tissue disorders		
Dermatitis allergic	0	2 (1.5%)
Dermatitis contact	0	2 (1.5%)
Vascular disorders		
Hypertension	0	2 (1.5%)
Psychiatric disorders		
Insomnia	0	2 (1.5%)

Chronic Idiopathic Urticaria (CIU)

Adverse Drug Reaction Overview

The safety and tolerability of omalizumab were investigated with the doses of 75 mg, 150 mg and 300 mg every four weeks in 975 CIU patients, 242 of whom received placebo. 733 patients were treated with omalizumab for up to 12 weeks and 490 patients for up to 24 weeks. 175 and 412 patients were treated for up to 12 weeks and 87 and 333 patients were treated for up to 24 weeks at the recommended doses of 150 mg and 300 mg respectively.

During clinical studies with adult and adolescent patients (12 years of age and older) the most commonly reported adverse reactions observed were headache and nasopharyngitis.

Clinical Trial Adverse Drug Reactions

Adverse reactions (events occurring in $\geq 1\%$ of patients in any treatment group and $\geq 2\%$ more frequently in any omalizumab treatment group than in the placebo group after medical review) reported at the 150 mg and 300mg doses in the three pooled Phase III studies are listed by MedDRA system organ class (Table 3). Within each system organ class, the adverse reactions are ranked by frequency, with the most frequent reactions listed first.

Table 3 - All Adverse Events Occurring $\geq 1\%$ More Frequently in XOLAIR-Treated CIU Patients 12 to 75 years of Age Compared with Placebo, Regardless of Causality Assessment between Day 1 and Week 12 in either XOLAIR 150 mg or 300 mg

Adverse Reactions (By MedDRA Preferred Term)	Omalizumab Asteria I, Asteria II and Glacial Studies Pooled		
	Omalizumab 150 mg (N=175)	Omalizumab 300 mg (N=412)	Placebo (N=242)
Ear and labyrinth disorders			
Vertigo	2 (1.14%)	1 (0.24%)	2(0.83%)
Gastrointestinal disorders			
Diarrhea	2 (1.14%)	12 (2.91%)	7 (2.89%)
Nausea	2 (1.14%)	11 (2.67%)	6 (2.48%)
Abdominal Pain Upper	2 (1.14%)	2 (0.49%)	2 (0.83%)
Flatulence	2 (1.14%)	2 (0.49%)	0 (0.00%)
Toothache	2 (1.14%)	2 (0.49%)	1 (0.41%)
Abdominal Pain	3 (1.71%)	1 (0.24%)	4 (1.65%)
General disorders and administration site conditions			
Fatigue	0 (0.00%)	7 (1.70%)	3 (1.24%)
Oedema Peripheral	3 (1.71%)	4 (0.97%)	1 (0.41%)
Influenza Like Illness	2 (1.14%)	1 (0.24%)	0 (0.00%)
Infections and infestations			
Nasopharyngitis	16 (9.14%)	27 (6.55%)	17 (7.02%)
Sinusitis	2 (1.14%)	20 (4.85%)	5 (2.07%)
Upper Respiratory Tract Infection	2 (1.14%)	14 (3.40%)	5 (2.07%)
Urinary Tract Infection	3 (1.71%)	6 (1.46%)	1 (0.41%)
Viral Upper Respiratory Tract Infection	4 (2.29%)	2 (0.49%)	0 (0.00%)
Fungal Infection	3 (1.71%)	2 (0.49%)	1 (0.41%)
Pharyngitis	2 (1.14%)	1 (0.24%)	0 (0.00%)
Musculoskeletal and connective tissue disorders			
Arthralgia	5 (2.86%)	12 (2.91%)	1 (0.41%)
Pain In Extremity	3 (1.71%)	4 (0.97%)	1 (0.41%)
Musculoskeletal Pain	3 (1.71%)	0 (0.00%)	1 (0.41%)
Bursitis	2 (1.14%)	0 (0.00%)	0 (0.00%)
Nervous system disorders			
Headache	21 (12.00%)	25 (6.07%)	7 (2.89%)

Presyncope	2 (1.14%)	3 (0.73%)	0 (0.00%)
Respiratory, thoracic and mediastinal disorders			
Cough	2 (1.14%)	9 (2.18%)	3 (1.24%)
Asthma	1 (0.57%)	5 (1.21%)	1 (0.41%)
Nasal Congestion	2 (1.14%)	3 (0.73%)	2 (0.83%)
Oropharyngeal Pain	3 (1.71%)	2 (0.49%)	4 (1.65%)
Skin and subcutaneous tissue disorders			
Alopecia	1 (0.57%)	6 (1.46%)	2 (0.83%)
Eczema	2 (1.14%)	4 (0.97%)	2 (0.83%)
Dry Skin	2 (1.14%)	0 (0.00%)	0 (0.00%)
Vascular disorders			
Hypertension	2 (1.14%)	2 (0.49%)	1 (0.41%)

Additional events reported anytime during the day 1 to week 24 treatment period (ASTERIA I and GLACIAL studies) that met the criteria of adverse reactions:

Musculoskeletal and connective tissue disorders: myalgia (placebo 0%, 150 mg 2.3%, 300 mg 0.9%).

General disorders and administration site conditions: pyrexia (placebo 1.2%, 150 mg 3.4%, 300 mg 0.9%).

Injection site reactions: Injection site reactions occurred during the studies in more omalizumab-treated patients than placebo patients (2.7% at 300 mg, 0.6% at 150 mg, 0.8% with placebo). These included: swelling, erythema, pain, bruising, itching, bleeding and urticaria.

Postmarketing Adverse Drug Reactions

The following reactions have been identified through spontaneous reportings in asthma patients.

Immune system disorders: Anaphylaxis and anaphylactoid reactions have uncommonly been reported following the first or subsequent administrations; serum sickness has been rarely reported.

Anaphylaxis: In post-marketing reports, the frequency of anaphylaxis in patients exposed to XOLAIR use was estimated to be 0.2% based on a total number of anaphylactic reactions observed from an estimated exposure of over 500,000 patient years. Diagnostic criteria of anaphylaxis were skin or mucosal tissue involvement, and, either airway compromise, and/or reduced blood pressure with or without associated symptoms, and a temporal relationship to XOLAIR administration with no other identifiable cause. Signs and symptoms in these reported cases included angioedema of the throat or tongue, bronchospasm, chest tightness, cough, cutaneous angioedema, dyspnea, hypotension, syncope, and/or urticaria. Pulmonary involvement was reported in 89% of the cases. Hypotension or syncope was reported in 14% of cases. A previous history of anaphylaxis unrelated to XOLAIR was reported in 24% of the cases. A history of anaphylaxis unrelated to omalizumab may be a risk factor for anaphylaxis following XOLAIR administration.

Of the reported cases of anaphylaxis attributed to XOLAIR, 39% occurred with the first dose,

19% occurred with the second dose, 10% occurred after the third dose, and the rest after subsequent doses. One case occurred after 39 doses (after 19 months of continuous therapy followed by a 3 month gap, anaphylaxis occurred upon restarting). The time to onset of anaphylaxis in these cases was 30 minutes or less in 35%, 30 to less than 60 minutes in 16%, 60 to less than 90 minutes in 2%, 90 to less than 120 minutes in 6%, 2 hours to 6 hours in 5%, 6 to 12 hours in 14%, 12 to 24 hours in 8%, 24 hours to 48 hours in 2% and 48 hours to 4 days in 2%. In 9% of cases the times to onset were unknown.

Fifteen percent of the reported cases resulted in hospitalization. Twenty-three patients who experienced anaphylaxis were re-challenged with XOLAIR and 18 had a recurrence of similar symptoms of anaphylaxis. Four patients who received XOLAIR, from all reported anaphylaxis cases, experienced urticaria and upon re-exposure developed anaphylaxis.

Blood and lymphatic system disorders: idiopathic severe thrombocytopenia

Musculoskeletal and connective tissue disorders: arthralgia, myalgia, joint swelling.

Respiratory, thoracic and mediastinal disorders: allergic granulomatous angiitis (i.e. Churg Strauss syndrome).

Skin and subcutaneous disorders: alopecia.

DRUG INTERACTIONS

Overview

No formal drug interaction studies have been performed with XOLAIR (omalizumab).

Drug-Drug Interactions

Cytochrome P₄₅₀ enzymes, efflux pumps and protein binding mechanisms are not involved in the clearance of omalizumab; thus, there is little potential for drug-drug interactions. There is no pharmacological reason to expect that commonly prescribed medications used in the treatment of asthma, CRSwNP or CIU will interact with omalizumab.

Asthma

In clinical studies XOLAIR was commonly used in conjunction with inhaled and oral corticosteroids, inhaled short-acting and long-acting beta agonists, leukotriene modifiers, theophyllines and oral antihistamines. There was no indication that safety of XOLAIR was altered with these other commonly used asthma medications. The concomitant use of XOLAIR and allergen immunotherapy has not been evaluated.

Chronic Rhinosinusitis with Nasal Polyps (CRSwNP)

In clinical studies XOLAIR was used in conjunction with intranasal mometasone spray per protocol. Other commonly used concomitant medications included other intranasal corticosteroids, bronchodilators, antihistamines, leukotriene receptor antagonists, adrenergics/sympathomimetics, and local nasal anesthetics.

Chronic Idiopathic Urticaria

In CIU clinical studies, XOLAIR was used in conjunction with antihistamines (anti-H1, anti-H2) and leukotriene receptor antagonists (LTRAs). There was no evidence that the safety of omalizumab was altered when used with these medicinal products relative to its known safety profile in asthma. In addition, a population pharmacokinetic analysis showed no relevant effect of H2 antihistamines and LTRAs on omalizumab pharmacokinetics (see ACTION AND CLINICAL PHARMACOLOGY).

The combination of XOLAIR with immunosuppressive therapies has not been studied in patients with CIU.

DOSAGE AND ADMINISTRATION

Dosing Considerations for Asthma

XOLAIR (omalizumab) 75 to 375 mg is administered SC every 2 or 4 weeks. See the dose determination charts below for appropriate dose assignment. Doses (mg) and dosing frequency are determined by serum total IgE level (IU/mL), measured before the start of treatment, and body weight (kg). Doses of more than 150 mg are divided among more than one injection site to limit injections to not more than 150 mg per site. Because the solution is slightly viscous, the injection may take 5-10 seconds to administer.

The need for continued therapy should be periodically reassessed based upon the patient's disease severity and level of asthma control.

Recommended Dose for Asthma Patients

- Adult and adolescent patients 12 years of age and older: Initiate dose according to Table 4.
- Pediatric patients 6 to <12 years of age: initiate dose according to Table 5.

Table 4 - XOLAIR doses (mg) administered by subcutaneous injection every 4 weeks (light-grey area) or 2 weeks (white area) for adult and adolescents 12 years of age and older for allergic asthma

Baseline IgE (IU/mL)*	Dosing Freq.	Body weight (kg)								
		≥20-30	>30-40	>40-50	>50-60	>60-70	>70-80	>80-90	>90-125	>125-150
≥30-100	Every 4 weeks	150	150	150	150	150	150	150	300	300
>100-200		150	150	300	300	300	300	300	225	300
>200-300		150	300	300	300	225	225	225	300	375
>300-400		300	300	225	225	225	300	300	DO NOT DOSE	
>400-500		300	225	225	300	300	375	375		
>500-600		300	225	300	300	375				
>600-700	Every 2 weeks	225	225	300	375					

*1 IU /mL = 2.4 ng/mL = 2.4 mcg/L

≥30-100 IU/mL = ≥72-240 ng/mL

>100-200 IU/mL = >240-480 ng/mL

>200-300 IU/mL = >480-720 ng/mL

>300-400 IU/mL = >720-960 ng/mL

>400-500 IU/mL = >960-1200 ng/mL

>500-600 IU/mL = >1200-1440 ng/mL

>600-700 IU/mL = >1440-1680 ng/mL

Table 5 - XOLAIR doses (mg) administered by subcutaneous injection every 4 weeks (light-grey area) or 2 weeks (white area) for children 6 to <12 years of age for allergic asthma

Baseline IgE (IU/mL)*	Dosing Freq.	Body Weight (kg)									
		20-25	>25-30	>30-40	>40-50	>50-60	>60-70	>70-80	>80-90	>90-125	>125-150
		Dose (mg)									
30-100	Every 4 weeks	75	75	75	150	150	150	150	150	300	300
>100-200		150	150	150	300	300	300	300	300	225	300
>200-300		150	150	225	300	300	225	225	225	300	375
>300-400		225	225	300	225	225	225	300	300		
>400-500		225	300	225	225	300	300	375	375		
>500-600		300	300	225	300	300	375				
>600-700		300	225	225	300	375					
>700-800	Every 2 weeks	225	225	300	375						
>800-900		225	225	300	375						
>900-1000		225	300	375							
>1000-1100		225	300	375							
>1100-1200		300	300								
>1200-1300		300	375								

*1 IU /mL = 2.4 ng/mL = 2.4 mcg/L
 ≥30-100 IU/mL = ≥72-240 ng/mL
 >100-200 IU/mL = >240-480 ng/mL
 >200-300 IU/mL = >480-720 ng/mL
 >300-400 IU/mL = >720-960 ng/mL
 >400-500 IU/mL = >960-1200 ng/mL
 >500-600 IU/mL = >1200-1440 ng/mL
 >600-700 IU/mL = >1440-1680 ng/mL
 >700-800 IU/mL = >1680-1920 ng/mL
 >800-900 IU/mL = >1920-2160 ng/mL
 >900-1000 IU/mL = >2160-2400 ng/mL
 >1000-1100 IU/mL = >2400-2640 ng/mL
 >1100-1200 IU/mL = >2640-2880 ng/mL
 >1200-1300 IU/mL = >2880-3120 ng/mL

Dosing Considerations for Chronic Rhinosinusitis with Nasal Polyps (CRSwNP)

The appropriate dose and dosing frequency of XOLAIR for these conditions is determined by baseline immunoglobulin E (IgE) (IU/mL), measured before the start of treatment, and body weight (kg). Prior to initial dosing, patients should have their IgE level determined by any commercial serum total IgE assay for their dose assignment. Based on these measurements 75 to 600 mg of XOLAIR in 1 to 4 injections may be needed for each administration. See Table 8 for a conversion chart and Table 6 for dose determination. For doses of 225, 375 or 525 mg XOLAIR, 150 mg can be used in combination with XOLAIR 75 mg.

Patients whose baseline IgE levels or body weight in kilograms are outside the limits of the dosing table should not be given XOLAIR. In clinical trials for nasal polyps, changes in nasal polyps score (NPS) and nasal congestion score (NCS) were observed as early as the first assessment at 4 weeks.

Recommended Dose for Chronic Rhinosinusitis with Nasal Polyps (CRSwNP)

Table 6 - Subcutaneous XOLAIR Doses Every 2 or 4 Weeks* for Adult Patients with CRSwNP

Pretreatment Serum IgE (IU/mL)	Dosing Freq.	Bodyweight								
		>30-40 kg	>40-50 kg	>50-60 kg	>60-70 kg	>70-80 kg	>80-90 kg	>90-125 kg	> 125-150 kg	
		Dose (mg)								
30 - 100	Every 4 Weeks	75	150	150	150	150	150	300	300	
>100 - 200		150	300	300	300	300	300	450	600	
>200 - 300		225	300	300	450	450	450	600	375	
>300 - 400		300	450	450	450	600	600	450	525	
>400 - 500		450	450	600	600	375	375	525	600	
>500 - 600		450	600	600	375	450	450	600		
>600 - 700		450	600	375	450	450	525			
>700 - 800	Every 2 Weeks	300	375	450	450	525	600			
>800 - 900		300	375	450	525	600				
>900 - 1000		375	450	525	600					
>1000 - 1100		375	450	600						
>1100 - 1200		450	525	600	Insufficient Data to Recommend a Dose					
>1200 - 1300		450	525							
>1300 - 1500		525	600							

*Dosing frequency:

- Subcutaneous doses to be administered every 4 weeks
- Subcutaneous doses to be administered every 2 weeks

The need for continued therapy should be periodically reassessed based upon the patient's disease severity and level of symptom control.

Dosing Adjustments for Asthma Patients and Chronic Rhinosinusitis with Nasal Polyps (CRSwNP)

Total IgE levels are elevated during treatment and remain elevated for up to one year after the discontinuation of treatment. Therefore, re testing of IgE levels during XOLAIR treatment

cannot be used as a guide for dose determination. Dose determination after treatment interruptions lasting less than 1 year should be based on serum IgE levels obtained at the initial dose determination. Total serum IgE levels may be re tested for dose determination if treatment with XOLAIR has been interrupted for one year or more.

Doses should be adjusted for significant changes in body weight (See dosing charts under Recommended Dose for Asthma Patients and Recommended Dose for CRSwNP).

Dosing Considerations for Chronic Idiopathic Urticaria

XOLAIR (omalizumab) 150 mg or 300 mg are administered subcutaneously every 4 weeks. The efficacy of XOLAIR in CIU patients is dose dependent (see PART II, CLINICAL TRIALS, Chronic Idiopathic Urticaria).

Prescribers are advised to periodically reassess the need for continued therapy. Clinical trial experience of long-term treatment beyond 6 months in this indication is limited.

Dosing of XOLAIR in CIU patients is not dependent on serum IgE (free or total) level or body weight.

Renal or hepatic impairment

There have been no studies on the effect of impaired renal or hepatic function on the pharmacokinetics of XOLAIR. While no particular dose adjustment is recommended, XOLAIR should be administered with caution in these patients (see WARNINGS AND PRECAUTIONS).

Missed Dose

Patients who miss a dose of XOLAIR should be advised to contact their doctor to find out when to take their next dose of XOLAIR.

Incompatibilities

Powder and solvent for solution for injection: XOLAIR must not be mixed with any medication or diluents other than sterile water for injection.

Solution for injection in pre-filled syringe: This medicinal product must not be mixed with other medicinal products.

Administration

XOLAIR is for subcutaneous administration only. Do not administer by the intravenous or intramuscular route.

Treatment is intended to be administered by a healthcare provider only.

The injections are administered in the deltoid region of the arm or thigh. If more than one injection at a time is required, repeat the injection in the opposite thigh or arm, avoiding urticarial lesions.

Table 7 - Number of Injections and Total Injection Volumes

Dose (mg)	XOLAIR Lyophilized Powder for reconstitution in 150 mg vial		XOLAIR solution for injection in 75/150 mg pre-filled syringe	
	Number of injections (vials needed)	Total Volume Injected (mL)	Number of injections (pre-Filled syringes needed)	Total Volume Injected (mL)
75	1	0.6	1 x 75 mg	0.5
150	1	1.2 ^a	1 x 150 mg	1.0
225	2	1.8	1 x 150 mg + 1 x 75 mg	1.5
300	2	2.4	2 x 150 mg	2.0
375	3	3.0	2 x 150 mg + 1 x 75 mg	2.5
450	3	3.6	3 x 150 mg	3.0
525	4	4.2	3 x 150 mg + 1 x 75 mg	3.5
600	4	4.8	4 x 150 mg	4.0

^a 1.2 mL maximum delivered volume per 150 mg vial

This table presents all possible doses for all indications of XOLAIR. Dose level should be restricted to those in the Recommended Dose and Dosing Considerations sections for each authorized indication.

Instructions for use and handling of XOLAIR powder vial

Reconstitution:

Parenteral Products:

Vial Size	Volume of Diluent to be Added to Vial	Approximate Available Volume	Nominal Concentration per mL
6 mL	1.4 mL	1.2 mL	150 mg per 1.2 mL (125 mg/mL)

Please read carefully before reconstitution. Failure to do so may result in unusable product.

XOLAIR for subcutaneous administration should be prepared using sterile water for injection (SWFI), USP ONLY.

XOLAIR is for single use only. It is recommended that XOLAIR be used immediately following reconstitution as there is no preservative in the formulation. Chemical and physical stability of the reconstituted product has been demonstrated for 8 hours at 2°C to 8°C and for 4 hours at 30°C. From a microbiological point of view, the product should be used immediately after

reconstitution. If not used immediately, in-use storage times and conditions prior to use are the responsibility of the user and should normally not be longer than 8 hours at 2°C to 8°C or 2 hours at 25°C.

The lyophilized product takes 15-20 minutes to dissolve. The fully reconstituted product will appear clear to slightly opalescent, colorless to pale brownish-yellow and may have a few small bubbles or foam around the edge of the vial. The reconstituted product is somewhat viscous; in order to obtain the full 1.2 mL dose ALL OF THE PRODUCT MUST BE WITHDRAWN from the vial before expelling any air or excess solution from the syringe.

STEP 1: Draw 1.4 mL of SWFI, USP into a 3-cc syringe equipped with a 1 inch, 18 gauge needle.



STEP 2: Place the vial upright on a flat surface and using standard aseptic technique, insert the needle and inject the SWFI, USP directly onto the product.

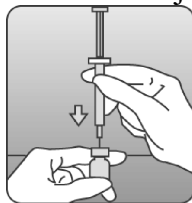

STEP 3: Keeping the vial upright, gently swirl the upright vial for approximately 1 minute to evenly wet the powder. Do not shake.



STEP 4: After completing STEP 3, gently swirl the vial for 5 to 10 seconds approximately every 5 minutes in order to dissolve any remaining solids. There should be no visible gel-like particles in the solution. Do not use if foreign particles are present.

Note: Some vials may take longer than 20 minutes to dissolve completely. If this is the case, repeat STEP 4 until there are no visible gel like particles in the solution. It is acceptable to have small bubbles or foam around the edge of the vial. Do not use if the contents of the vial do not dissolve completely by 40 minutes.

STEP 5: Invert the vial for 15 seconds in order to allow the solution to drain toward the stopper. Using a new 3-cc syringe equipped with a 1 inch, 18 gauge needle, insert the needle into the inverted vial. Position the needle tip at the very bottom of the solution in the vial stopper when drawing the solution into the syringe. Before removing the needle from the vial, pull the plunger all the way back to the end of the syringe barrel in order to remove all of the solution from the inverted vial.



STEP 6: Replace the 18 gauge needle with a 25 gauge needle for subcutaneous injection.

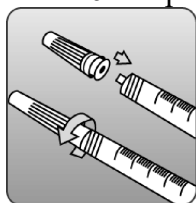

STEP 7: Expel air, large bubbles, and any excess solution in order to obtain the required volume of XOLAIR, 0.6 mL corresponding to 75 mg of XOLAIR or 1.2 mL corresponding to 150 mg XOLAIR. A thin layer of small bubbles may remain at the top of the solution in the syringe. Because the solution is slightly viscous, the injection may take 5 to 10 seconds to administer.

A vial delivers 1.2 mL (150 mg) of XOLAIR. For a 75 mg dose, withdraw all of the product from the vial before expelling any excess solution in order to obtain 0.6 mL into the syringe and discard the remaining product (see Table 7 above).

As with all parenteral admixtures, the constituted product should be examined for the presence of foreign particles, agglomeration or discoloration. Any defective units should be discarded.

STEP 8: Dispose the used syringe and needle immediately in a sharps container.

Special precautions for disposal for XOLAIR powder vial:

Any unused product or waste material should be disposed of in accordance with local requirements.

Instructions for use and handling of XOLAIR solution for injection in pre-filled syringe

The following information is intended for medical or healthcare professionals only.

Before using the syringe, please read the following information carefully.

Each XOLAIR pack contains a pre-filled syringe individually sealed in a plastic wrapper.

Parts of the pre-filled syringe

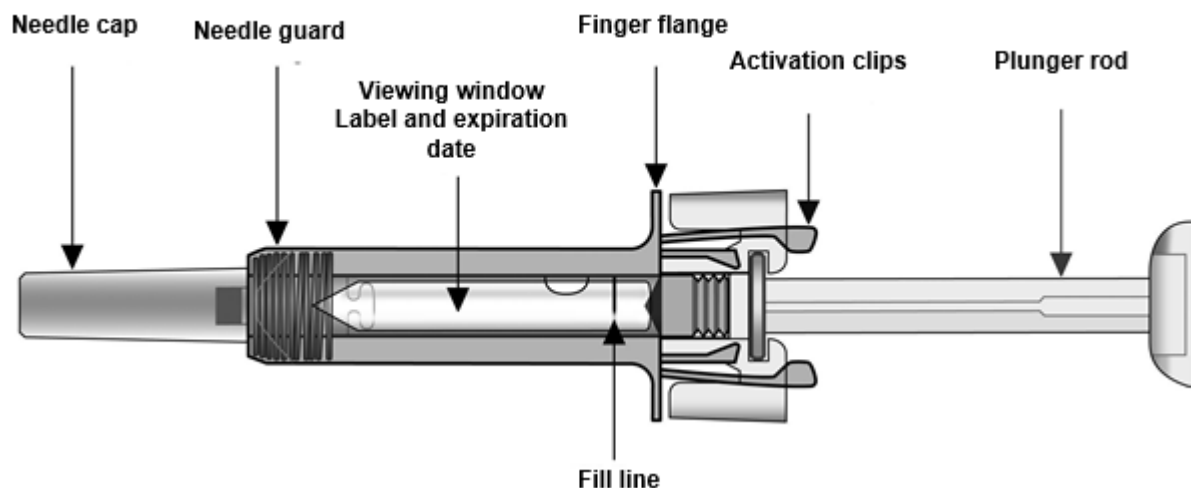

Important Safety Information

Caution: Keep the syringe out of the reach of children.

1. The needle cap of the syringe may contain dry rubber (latex), which should not be handled by persons sensitive to this substance.
2. Do not open the sealed outer box until you are ready to use the syringe.
3. Do not use the syringe if either the seal on the outer box or the plastic wrapper is broken, as it may be not safe for you to use.
4. Never leave the syringe where others might tamper with it.
5. Be careful not to touch the device activation clips (see first illustration) at any time. By touching them, the safety device may self-activate.
6. Do not remove the needle cap until just before you give the injection.
7. The syringe cannot be re-used. Dispose of the used syringe immediately after use.

Preparing the syringe for use

Warning: Prior to completion of the injection, avoid contact with the device activation clips (see first illustration) to keep from prematurely covering the needle with the needle guard.

1. Take the box containing the syringe out of the refrigerator and leave it for about 20 minutes so that it reaches room temperature (leave the syringe in the box to protect it from light).
2. If necessary, the syringe can be returned to the refrigerator for use at a later time, but this must not be done more than once. The cumulative time during which the syringe is kept at room temperature (25°C) must not exceed 4 hours.
3. When you are ready to use the syringe, wash your hands thoroughly with soap and water.
4. Clean the injection site.
5. Remove the plastic tray from the box, peel back the paper cover, and remove the syringe.
6. Inspect the syringe. DO NOT USE if it is broken or if the liquid looks cloudy or contains particles. In all these cases, return the entire product pack to the pharmacy.

7. Hold the syringe horizontally as shown below, look into the viewing window to check the dose (75 mg or 150 mg) of medicine and the expiration date printed on the label. Note: Rotate the internal syringe as shown below so the label can be read in the viewing window.

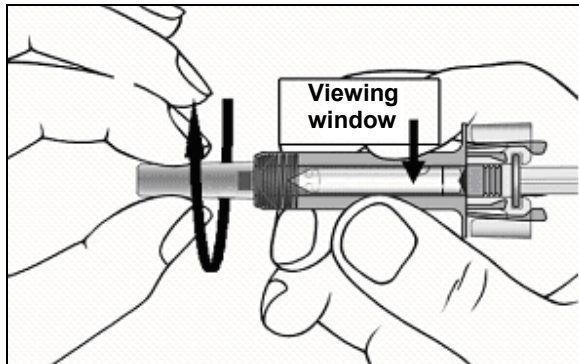

DO NOT USE if the product has expired or if the dose is incorrect. In either case, return the entire product pack to the pharmacy.

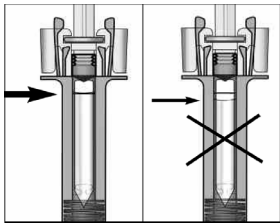

8. Hold the syringe vertically with the plunger uppermost and tap the side of the syringe against your finger to allow the air bubble to rise.
9. Check to see if the liquid level is at or above the minimum fill line. If the liquid is below the fill line, return the entire pack to the pharmacy.

How to use the syringe

STEP 1: Holding the syringe with the needle pointing upwards, carefully pull off the needle cap from the syringe and discard it. Do not touch the exposed needle. Then, gently tap the syringe with your finger until the air bubble rises to the top of the syringe. Slowly push the plunger up to force the air bubble out of the syringe without inadvertently expelling solution.

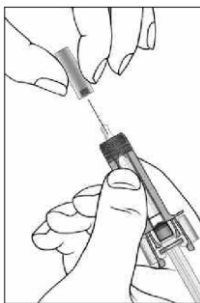

STEP 2: Gently pinch the skin at the injection site. Insert the needle into the skin fold.

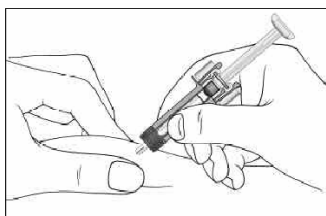

STEP 3: Holding onto the finger flange, slowly press the plunger all the way down until all the solution is injected. If any solution leaks from the injection site, insert the needle further.

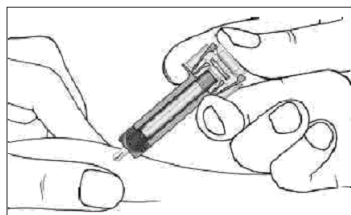

STEP 4: After the complete dose is given, remove the needle from the skin while holding the plunger down.

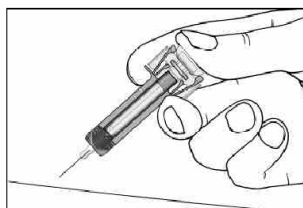

STEP 5: Slowly release the plunger and allow the needle guard to automatically cover the exposed needle.

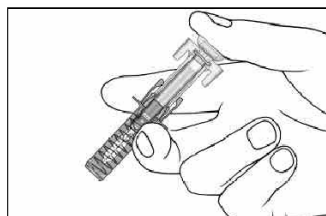

NOTE: If the needle guard does not extend automatically, firmly push on the plunger. Then release the plunger and allow the guard to cover the needle. Hold gauze on the injection site for approximately 30 seconds.

STEP 6: Dispose the used syringe immediately in a sharps container.

Special precautions for disposal for XOLAIR solution for injection in pre-filled syringe

Any unused product or waste material should be disposed of in accordance with local requirements.

OVERDOSAGE

For management of a suspected drug overdose, contact your regional Poison Control Centre.

The maximum tolerated dose of XOLAIR has not been determined. Single intravenous doses up to 4000 mg have been administered to patients without evidence of dose-limiting toxicities. The highest cumulative dose administered to patients was 44,000 mg over a 20-week period, which was not associated with toxicities.

ACTION AND CLINICAL PHARMACOLOGY

XOLAIR (omalizumab), an IgE blocker, is a breakthrough recombinant DNA-derived humanized monoclonal antibody that selectively binds to human immunoglobulin E (IgE). The antibody is an IgG1 kappa that contains human framework regions with the complementarity-determining regions of a murine antibody that binds to IgE.

XOLAIR is produced by a Chinese Hamster Ovary cell suspension culture in a nutrient medium containing the antibiotic gentamicin. Gentamicin is not detectable in the final product.

Mechanism of Action

IgE plays a central role in the pathophysiology of inflammatory diseases in the airway.

Omalizumab binds to IgE and prevents binding of IgE to the high-affinity IgE Receptor, FcεRI, thereby reducing the amount of free IgE that is available to trigger the allergic-inflammatory cascade.

Asthma and Chronic Rhinosinusitis with Nasal Polyps (CRSwNP)

Treatment of atopic subjects with omalizumab resulted in a significant ($p=0.0022$) marked down-regulation of FcεRI receptors on basophils. Furthermore, the in-vitro histamine release from basophils isolated from omalizumab treated subjects was reduced by approximately 90% following stimulation with an allergen compared to pre-treatment values.

Chronic Idiopathic Urticaria

Omalizumab binds to IgE and lowers free IgE levels. Subsequently, IgE receptors (FcεRI) on cells down-regulate. The mechanism by which these effects of omalizumab result in an improvement of CIU symptoms is unknown.

Pharmacodynamics

Asthma

In clinical studies in asthma patients, serum free IgE levels (i.e. unbound IgE) were reduced in a dose dependent manner within 1 hour following the first dose and maintained between doses. Mean serum free IgE decrease was greater than 96% using recommended doses. Serum total IgE levels (i.e., bound and unbound) increased after the first dose due to the formation of omalizumab:IgE complexes which have a slower elimination rate compared with free IgE. At 16 weeks after the first dose, average serum total IgE levels were five-fold higher compared with pre-treatment when using standard assays. After discontinuation of XOLAIR dosing, the XOLAIR induced increase in total IgE and decrease in free IgE were reversible with no observed rebound in IgE levels after drug washout. Total IgE levels returned to pre-treatment levels

within one year after discontinuation of XOLAIR.

Chronic Rhinosinusitis with Nasal Polyps (CRSwNP)

In clinical studies in patients with CRSwNP, XOLAIR treatment led to a reduction in serum free IgE and an increase in serum total IgE levels, to a similar extent as observed in patients with allergic asthma.

Chronic Idiopathic Urticaria

In clinical studies in CIU patients, omalizumab treatment led to a dose-dependent reduction of free IgE and an increase of total IgE levels in serum, similar to the observations in asthma patients. Maximum suppression of free IgE was observed 3 days after the first subcutaneous dose. After repeated dosing once every 4 weeks, pre-dose serum free IgE levels remained stable between 12 and 24 weeks of treatment. Total IgE levels in serum increased after the first dose due to the formation of omalizumab:IgE complexes which have a slower elimination rate compared with free IgE. After repeated dosing once every 4 weeks at 75 mg to 300 mg, average pre-dose serum total IgE levels at week 12 were two-to three-fold higher compared with pre-treatment levels, and remained stable between 12 and 24 weeks of treatment. After discontinuation of XOLAIR dosing, free IgE levels increased and total IgE levels decreased towards pre-treatment levels over a 16-week treatment-free follow-up period.

Pharmacokinetics

After SC administration, omalizumab is absorbed with an average absolute bioavailability of 62%. The pharmacokinetics of omalizumab are linear at doses greater than 0.5 mg/kg.

In vitro, omalizumab forms complexes of limited size with IgE. Precipitating complexes and complexes larger than 1 million daltons in molecular weight are not observed *in vitro* or *in vivo*. Tissue distribution studies in cynomolgus monkeys showed no specific uptake of ¹²⁵I-Omalizumab by any organ or tissue.

Clearance of omalizumab involves IgG clearance processes as well as clearance via specific binding and complex formation with its target ligand, IgE. Liver elimination of IgG includes degradation in the liver reticuloendothelial system (RES) and endothelial cells. Intact IgG is also excreted in bile. In studies with mice and monkeys, omalizumab:IgE complexes were eliminated by interactions with Fc γ receptors within the RES at rates that were generally faster than IgG clearance.

Asthma

Following a single SC dose in adult and adolescent patients with asthma, omalizumab was absorbed slowly, reaching peak serum concentrations after an average of 7-8 days. Following multiple doses of omalizumab, areas under the serum concentration-time curve from Day 0 to Day 14 at steady state were up to 6-fold of those observed after the first dose.

The apparent volume of distribution of omalizumab in patients with asthma following SC administration was 78 ± 32 mL/kg. In asthma patients omalizumab serum elimination half-life averaged 26 days, with apparent clearance averaging 2.4 ± 1.1 mL/kg/day. Doubling body weight approximately doubled apparent clearance.

Chronic Idiopathic Urticaria

Following a single subcutaneous dose in adult and adolescent patients with CIU, omalizumab was absorbed slowly, reaching peak serum concentrations after an average of 6 to 8 days.

In patients with CIU, omalizumab exhibited linear pharmacokinetics across the dose range of 75 mg to 600 mg given as a single subcutaneous dose. Following doses of 75 mg, 150 mg or 300 mg every 4 weeks, trough serum concentrations of omalizumab increased proportionally with the dose level.

Based on population pharmacokinetic, distribution of omalizumab in CIU patients was similar to that in patients with asthma.

In patients with CIU, based on population pharmacokinetic simulations, omalizumab serum elimination half-life at steady state averaged 24 days and apparent clearance at steady state averaged 260 mL/day (corresponding to 3.3 mL/kg/day for an 80 kg patient).

Special Populations and Conditions

Asthma

The population pharmacokinetics of XOLAIR in asthma patients were analyzed to evaluate the effects of demographic characteristics. Analyses of these limited data suggest that no dose adjustments are necessary for age (6-76 years), race, ethnicity or gender.

Chronic Rhinosinusitis with Nasal Polyps (CRSwNP)

The population pharmacokinetics analyses of omalizumab suggested that pharmacokinetics of omalizumab in CRSwNP were consistent with that in asthma. Analyses to evaluate the effects of demographic characteristics did not indicate a need for dose adjustment according to age (18-75 years) or gender. Race and ethnicity data were too limited in CRSwNP to inform dose adjustment.

Chronic Idiopathic Urticaria

The effects of demographic covariates and other factors on omalizumab exposure were evaluated using population pharmacokinetics. In addition, covariate effects were evaluated by analyzing the relationship between omalizumab concentrations and clinical responses. These analyses suggest that no dose adjustments are necessary in patients with CIU for age (12 to 75 years), race/ethnicity, gender, body weight, body mass index, baseline IgE, anti-FcεRI autoantibodies or concomitant use of H2 antihistamines or leukotriene receptor antagonists (LTRAs).

Hepatic and Renal Insufficiency: There have been no studies on the effect of impaired renal or hepatic function on the pharmacokinetics of XOLAIR. Because omalizumab clearance at clinical doses is dominated by the reticular endothelial system (RES) it is unlikely to be altered by renal or hepatic impairment. While no particular dose adjustment is recommended, XOLAIR should be administered with caution in these patients (see WARNINGS AND PRECAUTIONS).

Genetic Polymorphism: There have been no studies on the effect of genetic polymorphisms on the pharmacokinetics of XOLAIR.

STORAGE AND STABILITY

XOLAIR (omalizumab) should be stored under refrigerated conditions 2°-8°C. Do not freeze. Do not use beyond the expiration date stamped on carton.

Sterile powder for reconstitution (150 mg vial): XOLAIR is for single use only. It is recommended that XOLAIR be used immediately following reconstitution, as there is no preservative in the formulation. Chemical and physical stability of the reconstituted product has been demonstrated for 8 hours at 2°C to 8°C and for 4 hours at 30°C. From a microbiological point of view, the product should be used immediately after reconstitution. If not used immediately, in-use storage times and conditions prior to use are the responsibility of the user and should normally not be longer than 8 hours at 2°C to 8°C or 2 hours at 25°C.

Reconstituted XOLAIR vials should be protected from direct sunlight.

Pre-filled syringe (75mg and 150mg): Take the syringe out of the refrigerator and allow it to reach room temperature before preparing it for injection (about 20 minutes). The cumulative time during which the syringe is kept at room temperature (25°C) must not exceed 4 hours.

DOSAGE FORMS, COMPOSITION AND PACKAGING

XOLAIR (omalizumab) is supplied as:

Sterile powder for reconstitution (150 mg vial): XOLAIR (omalizumab) is a sterile, white to off-white, preservative-free, lyophilized powder contained in a single-use 6 mL vial that is reconstituted with sterile water for injection (SWFI), USP, and administered as a subcutaneous (SC) injection.

A XOLAIR vial contains 202.5 mg of the active substance, omalizumab, and the following non-medicinal ingredients: 145.5 mg sucrose (0.5 calories or 2.3 Joules), 2.8 mg L-histidine hydrochloride monohydrate, 1.8 mg L-histidine and 0.5 mg polysorbate 20. It is designed to deliver 150 mg omalizumab, in 1.2 mL, after reconstitution with 1.4 mL SWFI, USP.

Pre-filled syringe (75 mg and 150 mg): XOLAIR (omalizumab) is a solution in a single use pre-filled glass syringe with staked needle and rigid needle shield with a Clarity/Opalescence ≤ 30 NTU (Ph.Eur.) and Color \leq BY5. It is administered as a subcutaneous (SC) injection. The packaging includes:

- a syringe barrel, 1 mL long, colorless, hydrolytic class I, with staked 26G 1/2” needle. The interior of the barrel and the outer surface of the needle are siliconized.
- a grey plunger stopper, made of latex-free bromobutyl rubber, coated on the product contact side with a fluoro resin. The stopper is siliconized.
- a rigid needle shield consisting of a grey styrene butadiene rubber needle shield and a polypropylene rigid shell.

A XOLAIR (omalizumab) 75 mg/0.5 mL pre-filled syringe contains 75 mg of the active substance, omalizumab, and the following non-medicinal ingredients: 21.05 mg L-arginine

hydrochloride, 1.17 mg L-histidine hydrochloride, 0.68 mg L-histidine and 0.20 mg polysorbate 20 in 0.5 mL water for injection. It is designed to deliver 75 mg omalizumab, in 0.5 mL.

A XOLAIR (omalizumab) 150 mg/1 mL pre-filled syringe contains 150 mg of the active substance, omalizumab, and the following non-medicinal ingredients: 42.10 mg L-arginine hydrochloride, 2.34 mg L-histidine hydrochloride, 1.37 mg L-histidine and 0.40 mg polysorbate 20 in 1 mL water for injection. It is designed to deliver 150 mg omalizumab, in 1 mL.

PART II: SCIENTIFIC INFORMATION

PHARMACEUTICAL INFORMATION

Drug Substance

Proper name: Omalizumab

Chemical name: Recombinant humanized monoclonal antibody-E25 (rhuMAb-E25)

Molecular/Structural formula:

The amino acid sequence for the two light chains is as follows:

```
1   DIQLTQSPSSLSASVGDRTITCRASQSVD
31  YDGDSYMNWYQQKPGKAPKLLIYAASYLES
61  GVPSRFSGSGSGTDFTLTISSLQPEDFATY
91  YCQQSHEDPYTFGQGTKVEIKRTVAAPSVF
121 IFPPSDEQLKSGTASVVCLLNNFYPREAKV
151 QWKVDNALQSGNSQESVTEQDSKDESTYSL
181 STLTLKADYEKHKVYACEVTHQGLSSPVT
211 KSFNRGEC
```

The amino acid sequence of the two heavy chains is as follows:

```
1   EVQLVESGGGLVQPGGSLRLSCAVSGYSIT
31  SGYSWNWIRQAPGKGLEWVASITYDGSTNY
61  NPSVKGRITISRDDSKNTFYLMNSLRAED
91  TAVYYCARGSHYFGHWHFAVWGQGTLLVTVS
121 SASTKGPSVFPLAPSSKSTSGGTAALGCLV
151 KDYFPEPVTVSWNSGALTSGVHTFPAVLQS
181 SGLYSLSSVVTVPSSSLGTQTYICNVNHKP
211 SNTKVDKKVEPKSCDKTHTCPPCPAPELLG
241 GPSVFLFPPKPKDTLMISRTPEVTCVVVDV
271 SHEDPEVKFNWYVDGVEVHNAKTKPREEQY
301 NSTYRVVSVLTVLHQDWLNGKEYKCKVSNK
331 ALPAPIEKTISKAKGQPREPQVYTLPPSRE
361 EMTKNQVSLTCLVKGFYPSDIAVEWESNGQ
391 PENNYKTTTPVLDSDGSFFLYSKLTVDKSR
421 WQQGNVFSCSVMHEALHNHYTQKSLSLSPG
451 K
```

Molecular Mass: 149,170.6 Da.

Physicochemical properties: The mature rhuMAb-E25 molecule has two 218-residue

light chains and two 450- or 451-residue heavy chains, with the 450-residue form predominating. Each light chain is disulfide-bonded to a heavy chain. Interchain disulfide bonds attach the heavy chains to each other. One N-linked glycosylation site is present in the heavy chain constant region at a position (Asn-301) that is conserved in all human IgG1 antibodies. rhuMAB-E25 has >99% glycosylation at a single conserved site (Asn-H301) in the CH2 domain.

CLINICAL TRIALS

Asthma

Adult and Adolescent Patients 12 Years of Age and Older

The safety and efficacy for XOLAIR (omalizumab) were evaluated in four randomized, double-blind, placebo-controlled, multicenter trials (studies 1, 2, 3 and 4). Supplemental data from two open-label controlled studies in moderate to severe allergic asthma are also included (studies 5 and 6). XOLAIR dosing was based on body weight and baseline serum total IgE concentration.

Studies 1 and 2 were of similar design and are presented together. The two trials enrolled 1,071 atopic patients 12 to 76 years old, with moderate to severe persistent (NHLBI criteria) asthma for at least one year with a positive skin test reaction to a perennial aeroallergen. Patients were non-smoking asthmatics requiring daily treatment with inhaled corticosteroids (beclomethasone dipropionate), 420 to 1,008 micrograms per day, and a beta-agonist as needed (maximum 8 puffs per day).

Studies 1 and 2 were designed to evaluate asthma exacerbations. At screening, patients in Studies 1 (n=525) and 2 (n=546) had a forced expiratory volume in one second (FEV₁) between 40% and 80% predicted and were required to be symptomatic on entry. In both studies, entry criteria included demonstration of at least 12% improvement of FEV₁ following short acting beta agonist administration, concurrent treatment with inhaled corticosteroids (ICS) and short acting beta-agonists. Patients receiving other concomitant controller medications were excluded, as were current smokers. Initiation of additional controller medications while on study was prohibited.

Each study comprised a run-in period to achieve a stable conversion to a common ICS (beclomethasone dipropionate), followed by randomisation to XOLAIR or placebo. In both studies, patients received XOLAIR for 16 weeks with an unchanged ICS dose unless an acute exacerbation necessitated an increase. Patients then entered an ICS reduction phase of 12 weeks, during which ICS dose reduction was attempted in a step-wise manner.

In Studies 1 and 2 the distribution of the number of asthma exacerbations per patient in each group during the study was analysed separately for the stable steroid and steroid-reduction periods. The number of exacerbations was reduced in patients treated with XOLAIR compared with placebo (Table 8).

Table 8 - Frequency of asthma exacerbations per patient in Studies 1 and 2

	Stable Steroid phase (16 weeks)					
	Study 1		Study 2		Combined Studies 1 & 2	
Exacerbations per patient	XOLAIR N = 268 (%)	Placebo N = 257 (%)	XOLAIR N = 274 (%)	Placebo N = 272 (%)	XOLAIR N = 542 (%)	Placebo N = 529 (%)
≥ 1	14.6	23.3	12.8	30.5	13.7	26.9
P value	0.006 [†]		<0.001 [†]		<0.001 [†]	
Mean number of exacerbations per patient	0.28	0.54	0.28	0.66	0.28	0.6
	Steroid reduction phase (12 weeks)					
	Study 1		Study 2		Combined Studies 1 & 2	
Exacerbations per patient	XOLAIR N = 268 (%)	Placebo N = 257 (%)	XOLAIR N = 274 (%)	Placebo N = 272 (%)	XOLAIR N = 542 (%)	Placebo N = 529 (%)
≥ 1	21.3	32.3	15.7	29.8	18.5	31
P value	0.003 [†]		<0.001 [†]		<0.001 [†]	
Mean number of exacerbations per patient	0.39	0.66	0.36	0.75	0.38	0.71

[†] Van Elteren test

In both Studies 1 and 2, XOLAIR was superior to placebo with respect to the primary variable of asthma exacerbation (defined as worsening of asthma requiring systemic corticosteroids or a doubling of the patient's baseline beclomethasone dose). The analysis of the number of asthma exacerbations favoured XOLAIR over placebo during both the stable steroid periods and steroid sparing periods as shown in the table above.

In double-blind extension phases of both studies out to one year treatment the reduction in the frequency of asthma exacerbations for omalizumab treated patients compared to placebo-treated patients was maintained.

Results were also statistically significant in favour of XOLAIR compared to placebo with respect to percent reduction in the dose of inhaled beclomethasone dipropionate and for the amount of rescue medication required. These results are presented in Table 9.

Table 9- Number of puffs of rescue medication used (stabilization phase) and relative reduction in steroid usage (steroid-reduction phase)

Variable	Study 1		Study 2	
	XOLAIR (N=268)	Placebo (N=257)	XOLAIR (N=274)	Placebo (N=272)
<i>Stable steroid phase</i>				
Median puffs of rescue medication per day and p-value	3.18	3.71	2.0	3.67
	p=0.029		p<0.001	
<i>Steroid reduction phase</i>				
Median absolute reduction	420 µg	336 µg	500 µg	300 µg
Median relative % reduction and p-value	75 %	50 %	83 %	50 %
	p<0.001		p<0.001	
% patients with 100 % reduction	40	19	43	20

Results from the stable steroid phase of Study 2 and the steroid reduction phases of both Studies 1 and 2 were similar to those presented in Table 10.

Table 10 - Asthma Symptoms and Pulmonary Function During Stable Steroid Phase of Study 1

Endpoint	XOLAIR N=268 ^a		Placebo N=257 ^a	
	Mean Baseline	Median Change (Baseline to Wk 16)	Mean Baseline	Median Change (Baseline to Wk 16)
Total asthma symptom score	4.3	-1.5 ^b	4.2	-1.1 ^b
Nocturnal asthma score	1.2	-0.4 ^b	1.1	-0.2 ^b
Daytime asthma score	2.3	-0.9 ^b	2.3	-0.6 ^b
FEV1 % predicted	68	3 ^b	68	0 ^b

Asthma symptom scale: total score from 0 (least) to 9 (most); nocturnal and daytime scores from 0 (least) to 4 (most symptoms).

^a Number of patients available for analysis ranges 25-258 in the XOLAIR group and 238-239 in the placebo group.

^b Comparison of XOLAIR versus placebo (p<0.05).

In the pivotal studies (Studies 1 and 2), XOLAIR administration resulted in a substantial (6-fold) reduction in hospitalizations due to asthma exacerbations (13 vs 2 in the combined pivotal trials) and fewer premature discontinuations [60 (11.1%) vs 108 (20.4%) of patients] and discontinuations attributed to unsatisfactory therapeutic effect [5 (0.9%) vs 26 (4.9%) of patients].

In Studies 1 and 2, clinically meaningful improvement in asthma-related quality of life, measured by the validated Juniper's Asthma Quality of Life Questionnaire, was demonstrated in the XOLAIR group at the end of the 28-week core trial compared to that observed in the placebo treated group (difference from placebo $p \leq 0.001$ in Studies 1 and 2). The proportion of patients achieving a clinically meaningful improvement in Quality of Life i.e., demonstrating a ≥ 0.5 unit increase over the 28-week core trial, was 69% for the XOLAIR group compared to 55% for the placebo group in study 1, and 67 % for the XOLAIR group compared to 57% for the placebo group in study 2 ($p < 0.05$; Chi-squared test for each study separately).

In Study 3 the safety and corticosteroid sparing effect of omalizumab was demonstrated in 246 patients with severe allergic asthma requiring daily treatment with high-dose inhaled corticosteroids (fluticasone ≥ 1000 micrograms /day) and other concomitant asthma medications, including long acting beta 2-agonists. 246 patients were treated with high dose ICS and 95 patients treated with high dose ICS and oral steroids. The study included a 16-week steroid stable phase with study medication added, followed by a 16-week steroid reduction phase. Study 3 was specifically designed to evaluate steroid sparing effects rather than effect on asthma exacerbations. Efficacy was measured by a reduction in ICS use in the subpopulation of 246 patients treated with high dose ICS therapy.

The percent reduction in inhaled corticosteroid dose at the end of the treatment phase was significantly greater in omalizumab treated patients versus placebo patients (median 60% vs. 50%, $p=0.003$). The proportion of omalizumab patients who were able to reduce their fluticasone dose by $\geq 50\%$ was 73.83% versus 50.8% in the placebo group ($p>0.001$).

In study 4 the safety and efficacy of omalizumab were demonstrated in 405 patients aged 12-75 years with co-morbid allergic asthma and perennial allergic rhinitis. Eligible patients had both symptomatic allergic asthma and perennial allergic rhinitis. Patients were treated with omalizumab or placebo for 28 weeks as add on therapy to $\geq 400\mu\text{g}$ s of Budesonide Turbohaler. Inhaled long acting beta-2 agonists (39%) and nasal corticosteroids (17%) were allowed.

The co-primary endpoints for study 4 were the incidence of asthma exacerbations (worsening of asthma requiring systemic corticosteroids or a doubling of the patient's baseline budesonide dose) and the proportion of patients in each treatment group with a ≥ 1.0 improvement from baseline at the end of the treatment phase in both asthma and rhinitis specific quality of life assessments (Juniper Quality of Life Assessment). The results are presented in Table 11.

Patients treated with omalizumab had a significantly lower incidence of asthma exacerbations than patients receiving placebo (20.6% omalizumab vs 30.1% placebo, $p=0.02$) and there was a significantly higher proportion of omalizumab treated than placebo patients that improved by ≥ 1.0 points in both asthma and rhinitis specific quality of life assessments (57.7% omalizumab vs 40.6% placebo, $p < 0.001$).

The reduction in exacerbations and improvements of quality of life in omalizumab treated patients was seen in the context of statistically significant improvements in both rhinitis and asthma symptoms, and lung function, compared to placebo.

Table 11 - Asthma Exacerbations and Quality of Life in Study 4

Primary efficacy variable	Omalizumab N=209 n(%)	Placebo N=196 n(%)	p-value
Number of asthma exacerbation episode			
0	166 (79.4)	137 (69.9)	0.0200
≥1	43 (20.6)	59 (30.1)	
AQLQ and RQOL			
Responder	120 (57.7)	78 (40.6)	0.0005
Non-responder	88 (42.3)	114 (59.4)	
Missing	1	4	
Responder = improvement of ≥ 1.0 on both AQLQ & RQOL questionnaires			

In Study 4, a significant improvement from baseline was observed in XOLAIR treated patients compared to patients receiving placebo at study Endpoint in all 7 domains of the RQOL. A significant improvement at Study Endpoint in overall asthma-specific quality of life was observed in those patients administered XOLAIR compared to patients receiving placebo.

Studies 5 and 6 were open-label controlled studies in moderate to severe allergic asthma, where exacerbation data were collected. Study 5 was conducted for 52 weeks in 312 adult and adolescent patients aged 12-75 years with poorly controlled allergic asthma, and was designed primarily as an efficacy study evaluating the number of asthma deterioration related incidents (ADRI) defined as a course of antibiotic; a course of oral corticosteroid; work/school missing days due to asthma; hospital stay due to asthma; unscheduled physician visit; and/or ER visit due to asthma. Patients received omalizumab as add-on to current asthma treatment (median dose of inhaled corticosteroids was 2000 micrograms/day, 78% were receiving a long acting beta 2-agonist) or current asthma treatment alone. Patients had to have at least one asthma-related hospitalization or emergency room visit and at least one additional course of oral corticosteroids due to asthma in the previous year.

In Study 5, treatment with omalizumab led to a 61% reduction in clinically significant asthma exacerbation rate ($p < 0.001$) compared to current asthma therapy alone. This reduction in exacerbations was seen in the context of statistically significant improvements in asthma symptoms, lung function, rescue medication use, and Quality of Life.

Study 6 was an open-label study to evaluate the safety of subcutaneous omalizumab for 24 weeks in patients (aged 6 to 75 years) with predominantly severe persistent asthma already

treated with other therapies (ALTO). Eligible patients had moderate to severe persistent asthma and were treated for at least 30 days prior to screening with moderate daily doses of inhaled corticosteroids and/ or stable daily doses of oral corticosteroids with at least one of the following: long-acting β -adrenergic (salmeterol), leukotriene receptor antagonist (LTRA), xanthine derivatives, or sodium cromoglycate. Patients were randomized (2:1 ratio) to either active treatment or the control group. Treatment was given in combination with ongoing asthma treatment.

A total of 1899 patients were randomized and treated during the study including 1262 omalizumab and 637 control patients. Although primarily undertaken to evaluate safety, efficacy was assessed by the incidence of protocol-defined asthma exacerbation episodes during the treatment phase and nocturnal symptoms as measured by the modified Inner City Asthma Study Morbidity Assessment (Mitchell et al 1997). Patients treated with omalizumab experienced 21% fewer protocol-defined asthma exacerbations (95% CI: 0.62, 0.99), 35% fewer asthma exacerbations resulting in hospitalizations (95% CI: 0.34, 1.22), 21% fewer asthma exacerbations resulting in ER visits (95% CI: 0.43, 1.54) and 20% fewer asthma exacerbations resulting in urgent medical visits (95% CI: 0.62, 1.03) compared with patients in the control group. Omalizumab patients had statistically significant reductions in nocturnal asthma symptoms ($p < 0.001$ at Weeks 4, 12 and 24) and overall asthma symptoms ($p < 0.05$) compared to the control group.

Throughout the clinical development program, all studies required that patients be treated with ICS at entry. In addition, several clinical studies (4,5,6) evaluated the safety and efficacy of XOLAIR when concomitantly administered to other commonly used asthma medications (including inhaled and oral corticosteroids, inhaled short-acting and long-acting beta agonists, leukotriene modifiers, theophyllines and oral antihistamines). There was no indication that the addition of XOLAIR altered the safety profile of these other commonly used asthma medications. Limited data are available on the use of XOLAIR in combination with specific immunotherapy (hypo-sensitisation therapy).

A Poisson regression was used to investigate the effect of omalizumab treatment on asthma exacerbation rates in patients receiving concomitant LABAs compared to those patients not receiving concomitant LABAs (Table 12). None of these studies were designed to evaluate the subpopulation with and without LABA separately or make direct comparisons, however, a consistent numerical benefit is observed for patients treated with omalizumab versus placebo in these analyses.

Table 12 - Clinically significant exacerbations for XOLAIR versus placebo in patients with LABA and without LABA use*

LABA use	Treatment	n	Number with no exacerbations	Number experiencing 1 or more exacerbations	Rate per period	Rate ratio (95% CI)
Study 4 (28 weeks)						
Yes	XOLAIR	86	68	18	0.35	0.615 (0.325 , 1.163)
	Placebo	71	46	25	0.58	
No	XOLAIR	123	98	25	0.25	0.621 (0.364 , 1.062)
	Placebo	125	91	34	0.40	
Study 5 (52 weeks)						
Yes	XOLAIR	167	78	89	1.05	0.425 (0.310 , 0.582)
	Control	84	20	64	2.47	
No	XOLAIR	39	24	15	0.67	0.272 (0.115 , 0.641)
	Control	22	8	14	2.47	
Study 6 (≥12 year olds, 24 weeks)						
Yes	XOLAIR	994	681	343	0.48	0.863 (0.707 , 1.052)
	Control	500	325	175	0.55	
No	XOLAIR	175	109	66	0.42	0.747 (0.459 , 1.218)
	Control	91	59	32	0.56	

* Based on Poisson models including terms for LABA use

Overall impact of XOLAIR administration on Quality of Life

With the exception of Study 6, which did not measure Quality of life, clinical studies 1 to 5 prospectively collected data on patient's asthma-specific quality of life by using the validated Juniper's Asthma Quality of Life Questionnaire. XOLAIR provided statistically and clinically meaningful greater improvement in asthma-specific quality of life over placebo. Improvements were demonstrated in all four asthma-specific domains of the Asthma Quality of Life Questionnaire, i.e., activities, symptoms, emotional function and environmental exposure as well as in the overall score. A summary of the proportion of patients' achieving a clinically meaningful improvement in the AQLQ is included in Table 13 below.

Table 13 - Clinically meaningful improvement in quality of life (Juniper AQLQ Change from baseline ≥ 0.5)

Study number	Omalizumab %	Placebo/Control %	p-value
1 (28 weeks)	66	55	<0.05
2 (28 weeks)	67	57	<0.05
3 (32 weeks)	52.3	35.7	0.004
4 (28 weeks)	78.8	69.8	0.002
5 (32 weeks)	71.8	43.2	<0.001

Pediatric Patients 6 to < 12 Years of Age

The safety and efficacy of XOLAIR in pediatric patients 6 to <12 years of age with moderate to severe asthma is based on one randomized, double-blind, placebo controlled, multi-center trial (Study 7) and an additional supportive study (Study 8).

Study 7 (Study IA05)

Study 7 was a 52-week study that evaluated the safety and efficacy of XOLAIR as add-on therapy in 628 pediatric patients ages 6 to <12 years with moderate to severe asthma inadequately controlled despite the use of inhaled corticosteroids (fluticasone propionate DPI ≥ 200 mcg/day or equivalent) with or without other controller asthma medications. Eligible patients were those with a diagnosis of asthma >1 year, a positive skin prick test to at least one perennial aeroallergen, and a history of clinical features such as daytime and/or night-time symptoms and exacerbations within the year prior to study entry. Entry criteria also included demonstration of at least 12% improvement in FEV1 following short-acting beta-agonist administration.

This study included a run-in period to achieve a stable and optimized conversion to a common ICS (fluticasone propionate DPI), followed by randomization to XOLAIR or placebo. The mean inhaled corticosteroid dose at baseline following the run-in period was 515.1 mcg/day (range: 119 to 1880 mcg/day).

During the first 24 weeks of treatment, steroid doses remained fixed from baseline. This was followed by a 28-week period during which inhaled corticosteroid adjustment was allowed in accordance with NHLBI guidelines.

The primary efficacy variable was the rate of clinically significant asthma exacerbations during the 24-week, fixed steroid treatment phase. A clinically significant exacerbation was defined as a worsening of asthma symptoms as judged clinically by the investigator, requiring doubling of the baseline inhaled corticosteroid dose for at least 3 days and/or treatment with rescue systemic

(oral or iv) corticosteroids for at least 3 days. The results of the rate of clinically significant asthma exacerbations during the initial 24-week fixed steroid treatment period and the entire 52-week double-blind treatment period are shown in Table 14.

Table 14 - Clinically significant asthma exacerbations during the 24-week fixed steroid treatment period and the 52-week double-blind treatment period

	Omalizumab N = 421	Placebo N = 206
24-Week Fixed Steroid Treatment Period		
Rate of clinically significant AEEs per 24-week fixed steroid treatment period	0.38	0.58
Rate ratio (Omalizumab/Placebo)*	0.66	
95% Confidence Interval	(0.53, 0.88)	
p-value	0.004	
52-Week Double-Blind Treatment Period^A		
Rate of clinically significant AEEs per 52-week treatment period	0.68	1.26
Rate ratio (Omalizumab/Placebo)*	0.54	
95% Confidence Interval	(0.42, 0.70)	
p-value	<0.001	

AEE: Asthma exacerbation (based upon observed events).

*Poisson regression including terms for treatment, country, dosing schedule and exacerbation history

^A 24-week, fixed steroid, treatment phase + 28-week, adjustable steroid, treatment phase

Baseline asthma medication use in addition to ICS:

- Short-acting beta-agonist: 87.2% omalizumab vs 87.9% placebo
- Inhaled long-acting beta-agonist: 65.8% omalizumab vs 70.5% placebo
- Anti-leukotrienes: 38.7% omalizumab vs. 32.4% placebo
- Maintenance oral steroid: 1.9% omalizumab vs 0% placebo
- Theophylline: 0.2% omalizumab vs 0% placebo

Other efficacy variables such as nocturnal symptom scores, beta-agonist rescue medication use, quality of life scores, total asthma symptom scores, and measures of airflow (FEV1) were not significantly different in XOLAIR-treated patients compared to placebo.

Study 8 (Study 010)

Study 8 was a 28-week randomized, double blind, placebo-controlled study that primarily evaluated safety in 334 pediatric patients. Of the randomized patients, 298 were aged 6 to <12 years of age, with moderate to severe asthma who were well-controlled with inhaled corticosteroids (beclomethasone dipropionate 168-420 mcg/day). During the first 16 weeks of treatment, steroid doses remained constant from baseline and this was followed by a 12-week steroid dose reduction period.

Although the primary endpoint of this study was to evaluate the safety and tolerability of XOLAIR compared to placebo (see ADVERSE REACTIONS), clinically significant asthma exacerbations were assessed as an exploratory endpoint. During the 16-week fixed steroid treatment period, the rate of clinically significant asthma exacerbation was 0.14 in patients

treated with XOLAIR compared to 0.25 in patients treated with placebo. During the 28-week treatment period, the rate of clinically significant asthma exacerbation was 0.32 in patients treated with XOLAIR compared to 0.66 in patients treated with placebo.

Chronic Rhinosinusitis with Nasal Polyps (CRSwNP)

The safety and efficacy of XOLAIR were evaluated in two randomized, multicenter, double-blind, placebo-controlled clinical trials (POLYP 1 and POLYP 2) that enrolled patients with chronic rhinosinusitis with nasal polyps (CRSwNP). All patients received background intranasal mometasone therapy throughout the study. Prior sino-nasal surgery or prior systemic corticosteroid usage were not required for inclusion in the studies. Patients received XOLAIR or placebo for 24 weeks. The co-primary endpoints were change from baseline of bilateral nasal polyp score (NPS) and average daily nasal congestion score (NCS) at Week 24. NPS was measured via endoscopy and the score ranged from 0-4 per nostril (the total NPS ranged from 0/best to 8/worst). Nasal congestion was measured by a daily NCS (range 0/best-3/worst). The inclusion criteria required that patients have NPS \geq 5 and weekly average of NCS $>$ 1 prior to randomization, despite use of intranasal mometasone.

Table 15 - Summary of study design and patient demographics for clinical trials in CRSwNP

Study #	Study design	Dosage, route of administration and duration	Study subjects (n)	Mean age (range)	Sex
GA39688 (POLYP 1)	Randomized, double-blind, placebo-controlled, parallel group, in adults with CRSwNP	SC omalizumab 150 mg Q4W to 600 mg Q2W per dosing table for Nasal Polyps SC placebo 24 weeks	Omalizumab: 72 Placebo: 66 Total: 138	51.0 years (19-74 years)	63.8% male 36.2% female
GA39855 (POLYP 2)	Randomized, double-blind, placebo-controlled, parallel group, in adults with CRSwNP	SC omalizumab 150 mg Q4W to 600 mg Q2W per dosing table for Nasal Polyps SC placebo 24 weeks	Omalizumab: 62 Placebo: 65 Total: 127	50.1 years (18-75 years)	65.4% male 34.6% female

Demographics were similar between the two trials, with 64.5% males, mean age 50.6 years with 15.1% of patients aged \geq 65 years, 97.0% white, with mean body weight 80.3 kg and mean baseline total IgE 175.0 IU/mL (range 30.0-1041.6 IU/mL). There were 94.3% of patients taking concomitant 400 mcg mometasone intranasal corticosteroid per day and 5.7% taking 200 mcg per day. There were 57.0% of patients with asthma, of which 64.9% had moderate or severe asthma severity. Past CRSwNP therapy included sinonasal surgery for 40.4% of patients, and 22.3% had taken systemic corticosteroids within the past year before study enrollment.

Study Results

Results for the co-primary endpoints and key secondary endpoints are presented in Table 16.

Table 16 – Results of co-primary and key secondary endpoints in CRSwNP trials

	POLYP 1		POLYP 2	
	Placebo	Xolair	Placebo	Xolair
N	66	72	65	62
Co-primary endpoints:				
Nasal polyp score (NPS) at Week 24				
Baseline mean	6.32	6.19	6.09	6.44
LS mean change at Week 24	0.06	-1.08	-0.31	-0.90
Treatment difference (95% CI)	-1.14 (-1.59, -0.69)*		-0.59 (-1.05, -0.12)*	
7-day average of daily nasal congestion score (NCS) at Week 24				
Baseline mean	2.46	2.40	2.29	2.26
LS mean change at week 24	-0.35	-0.89	-0.20	-0.70
Treatment difference (95% CI)	-0.55 (-0.84, -0.25)*		-0.50 (-0.80, -0.19)*	
Key secondary endpoints:				
Average daily sense of smell score				
Baseline mean	2.8	2.6	2.8	2.6
LS mean change at Week 24	-0.23	-0.56	-0.13	-0.58
SNOT-22 at Week 24				
Baseline mean	60.5	59.8	59.8	59.2
LS mean change at Week 24	-8.58	-24.70	-6.55	-21.59
Abbreviations: N = Total number of patients in the Full Analysis Set (includes all randomized patients grouped according to the treatment assigned at randomization); SNOT-22 = 22-item sino-nasal outcome test.				
Missing values, on or after the date of intercurrent event (requirement of rescue treatment or surgery; early discontinuation of treatment due to progress of disease, adverse events or loss of efficacy), were imputed by the worst observed score (prior to intercurrent event) of NPS and daily NCS, respectively.				
* 95% CIs between-group comparisons were obtained from a, respective, mixed-effect model of repeated measures (MMRM).				
A hierarchical testing procedure was used to control the overall Type I error rate (of 0.05) in each study.				

A key secondary endpoint was the assessment of the change from baseline at Week 24 of the total nasal symptom score (TNSS). Patient-reported TNSS was the sum of four equally weighted individual daily symptom scores: NCS, sense of smell score, posterior rhinorrhea score, and anterior rhinorrhea score. The TNSS ranged from 0/best-12/worst. The LS mean difference for change from baseline to Week 24 was -1.91 points (95% CI: -2.85, -0.96) in POLYP 1 and -2.09 points (95% CI: -3.00, -1.18) in POLYP 2.

Average daily UPSIT (University of Pennsylvania Smell Identification Test) scores range from 0 to 40 (0/worst-40/best). The LS mean difference for change from baseline to Week 24 in Xolair compared to placebo was 3.81 points (95% CI: 1.38, 6.24) in POLYP 1 and 3.86 points (95% CI:

1.57, 6.15) in POLYP 2.

Chronic Idiopathic Urticaria (CIU)

The clinical Phase III development program for CIU (also referred in some studies as Chronic Spontaneous Urticaria – CSU) included two randomized, double-blind, placebo controlled, parallel-group, multi-center studies: ASTERIA I (Q4881g) and ASTERIA II (Q4882g). ASTERIA I and ASTERIA II studies evaluated efficacy and safety of administration of 75 mg, 150 mg, or 300 mg XOLAIR every 4 weeks for 24 and 12 weeks respectively, with a 16-Week treatment free follow-up period in patients (12-75 years) with refractory CIU despite H1 antihistamine treatment as per approved dosage.

Disease severity was measured by a weekly urticaria activity score (UAS7, range 0–42), which is a composite of the weekly itch severity score (range 0–21) and the weekly number of hive score (range 0–21). In the two studies, the primary endpoint was the change from baseline to Week 12 in weekly itch severity score.

The mean weekly itch severity scores at baseline were balanced across treatment groups and ranged between 13.7 and 14.5 despite use of an H1 antihistamine at a recommended dose.

In both ASTERIA I and ASTERIA II Studies, patients who received XOLAIR 150 mg or 300 mg had greater decreases from baseline in weekly itch severity scores, weekly number of hive scores than placebo at Week 12 (Table 17 and Table 18). The 75 mg dose did not demonstrate consistent evidence of efficacy and is not considered an efficacious dose.

Table 17 - Summary of clinical outcomes at Week 12 in ASTERIA I study (mITT population[‡])

	XOLAIR 75mg (n = 77)	XOLAIR 150mg (n = 80)	XOLAIR 300mg (n =81)	Placebo (n = 80)
Weekly Itch Severity Score^a				
Mean Baseline Score (SD)	14.5 (3.6)	14.1 (3.8)	14.2 (3.3)	14.4 (3.5)
Mean Change Week 12 (SD)	-6.46 (6.14)	-6.66 (6.28)	-9.40 (5.73)	-3.63 (5.22)
Treatment Difference in LS Means* relative to the Placebo	-2.96	-2.95	-5.80	-
95%CI of the LS Mean difference relative to Placebo	-4.71, -1.21	-4.72, -1.18	-7.49, -4.10	-
p-value [§]	0.0010	0.0012	<0.0001	-
Weekly Number of Hives Score				
Mean Baseline Score (SD)	17.2 (4.2)	16.2 (4.6)	17.1 (3.8)	16.7 (4.4)
Mean Change Week 12 (SD)	-7.36 (7.52)	-7.78 (7.08)	-11.35 (7.25)	-4.37 (6.60)
Proportion of patients with UAS7 ≤ 6 at Week 12 n (%)	20 (26.0%)	32 (40.0%)	42 (51.9%)	9 (11.3%)
Proportion of patients with UAS7 =0 (no itch and no hives) at Week 12, n (%)	9 (11.7%)	12 (15.0%)	29 (35.8%)	7 (8.8%)

[‡] Modified intent-to-treat (mITT) population: patients who were randomized and received at least one dose of study medication.

*The LS mean was estimated using an ANCOVA model. The strata were baseline weekly itch severity score (< 13 vs. ≥13) and baseline weight (< 80 kg vs. ≥ 80 kg).

[§] p-value is derived from ANCOVA t-test.

- The testing strategy for the primary endpoint controlled the overall type I error rate of 0.05 across the three omalizumab doses.

- BOCF (Baseline Observation Carried Forward) was used to impute missing data for the endpoints of weekly itch severity score and number of hives score at week 12

-Patients were classified as UAS7>6 or a non-responder at week 12 if they had a missing value of UAS7 at week 12

Table 18 - Summary of clinical outcomes at Week 12 in ASTERIA II study (mITT population[‡])

	XOLAIR 75mg (n = 82)	XOLAIR 150mg (n = 82)	XOLAIR 300mg (n = 79)	Placebo (n = 79)
Weekly Itch Severity Score^a				
Mean Baseline Score (SD)	14.0 (3.7)	14.2 (4.1)	13.7 (3.5)	14.0 (3.4)
Mean Change Week 12 (SD)	-5.87 (6.45)	-8.14 (6.44)	-9.77 (5.95)	-5.14 (5.58)
Treatment Difference in LS Means* relative to the Placebo	-0.69	-3.04	-4.81	-
95%CI of the LS Mean difference relative to Placebo	2.54,1.16	-4.85, -1.24	-6.49, -3.13	-
p-value [§]	0.4637	0.0011	<0.0001	-
Weekly Number of Hives Score				
Mean Baseline Score (SD)	16.8 (4.2)	17.1 (4.1)	15.8 (4.6)	17.0 (4.2)
Mean Change Week 12 (SD)	-7.21 (6.96)	-9.75 (7.28)	-11.97 (7.58)	-5.22 (6.56)
Proportion of patients with UAS7 ≤ 6 at Week 12 n (%)	22 (26.8%)	35 (42.7%)	52 (65.8%)	15 (19.0%)
Proportion of patients with UAS7 =0 (no itch and no hives) at Week 12, n (%)	13 (15.9%)	18 (22.0%)	35 (44.3%)	4 (5.1%)

[‡] Modified intent-to-treat (mITT) population: patients who were randomized and received at least one dose of study medication.

*The LS mean was estimated using an ANCOVA model. The strata were baseline weekly itch severity score (< 13 vs. ≥13) and baseline weight (< 80 kg vs. ≥ 80 kg).

[§] p-value is derived from ANCOVA t-test.

- The testing strategy for the primary endpoint controlled the overall type I error rate of 0.05 across the three omalizumab doses.

- BOCF (Baseline Observation Carried Forward) was used to impute missing data for the endpoints of weekly itch severity score and number of hives score at week 12

-Patients were classified as UAS7>6 or a non-responder at week 12 if they had a missing value of UAS7 at week 12

Response over time

In both ASTERIA I and ASTERIA II, the mean weekly itch severity scores significantly decreased in both treatment groups with a maximum effect around week 12. In the two studies, the mean weekly itch severity score for both doses increased gradually during the 16-Week treatment-free follow-up period. Mean values at the end of the follow-up period were similar to the placebo group, but lower than the respective baseline values.

The mean weekly itch severity score at each study week by treatment groups is shown in Figure 1. Representative results from ASTERIA I are shown; similar results were observed in ASTERIA II.

Figure 1 - Mean Weekly Itch Severity Score by Treatment Group in ASTERIA I (mITT population[‡])

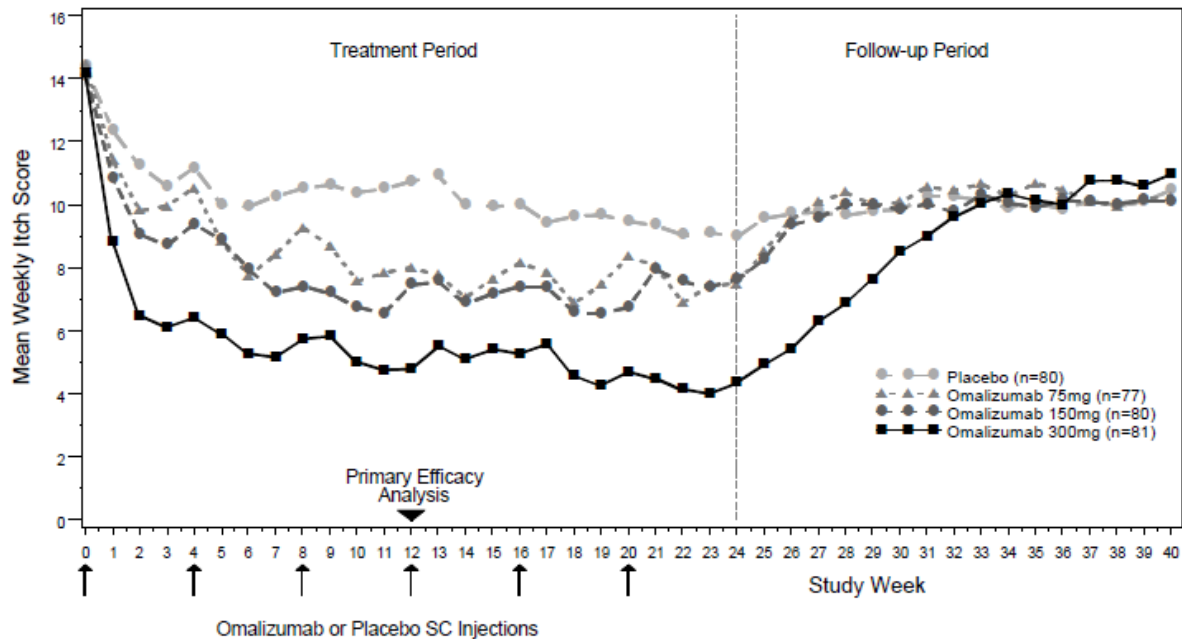

[‡] Modified intent-to-treat (mITT) population: patients who were randomized and received at least one dose of study medication.
 - BOCF (Baseline Observation Carried Forward) was used to impute missing data

Other Clinical Trials

A third study, GLACIAL, primarily evaluated the safety of XOLAIR 300 mg in patients with refractory CIU despite H1 antihistamines. The mean decrease from baseline to Week 12 in weekly itch severity score (the primary endpoint in ASTERIA I and ASTERIA II) was 4.01 in the placebo group and 8.55 in the XOLAIR group. The other efficacy endpoints in the study were those used as secondary endpoints in ASTERIA I. The magnitude of differences to placebo was consistent with those observed in ASTERIA I and ASTERIA II.

Comparative Bioavailability Study

Bioequivalence study of non-aged and aged XOLAIR solution for injection in pre-filled syringe versus XOLAIR lyophilized powder:

This was an open-label, randomized, three-parallel-group study to demonstrate the bioequivalence of both non-aged and aged XOLAIR solution for injection in pre-filled syringe (PFS) with XOLAIR lyophilized powder in subjects with elevated serum IgE levels (30-300 IU/mL). The non-aged solution was 6 to 12.7 months old post-manufacture at the time of administration. The aged solution mimicked a product when maintained at 2°-8°C (the required storage condition of XOLAIR; see STORAGE AND STABILITY Section) for approximately 18 months.

A total of 180 subjects were randomized to receive a single subcutaneous dose of one of the three formulations, either 150 mg or 300 mg of omalizumab depending on screening IgE (30-

300 IU/mL) and body weight (40-90 kg) (see *Recommended Dose and Dosage Adjustment for Asthma Patients*). The dose-normalized pharmacokinetic parameters (i.e., $AUC_{last}/dose$, $AUC_{inf}/dose$ and $C_{max}/dose$) of omalizumab were analyzed (see Table 19). Bioequivalence between the non-aged solution and the lyophilized powder as well as between the aged solution and the lyophilized powder were demonstrated.

Table 19 - Summary and statistical analysis of dose-normalized pharmacokinetic parameters of non-aged and aged XOLAIR solution for injection in pre-filled syringe versus XOLAIR lyophilized powder

Parameter	Non-aged XOLAIR solution for injection in 75/ or 150 mg pre-filled syringe	Aged XOLAIR solution for injection in 75/ or 150 mg pre-filled syringe	XOLAIR Lyophilized Powder for reconstitution in 150 mg vial	% Ratio of Geometric Means	90% Confidence Interval
	Omalizumab from measured data				
	Adjusted Geometric Mean Arithmetic Mean (CV %)				
Comparison non-aged solution versus lyophilized powder					
$AUC_{last}/dose$ [(ng•day/mL)/mg]	4985 5148 (21.8)	-	5344 5657 (33.3)	93	87–100
$AUC_{inf}/dose$ [(ng•day/mL)/mg]	5416 5624 (25.1)	-	5742 6091 (33.4)	94	87–102
$C_{max}/dose$ [(ng/mL)/mg]	137 141 (20.0)	-	143 151 (33.9)	95	88–103
T_{max} [day]	7* (2-21)*	-	7* (2-21)*	-	-
Comparison aged solution versus lyophilized powder					
$AUC_{last}/dose$ [(ng•day/mL)/mg]	-	5116 5228 (25.2)	5344 5657 (33.3)	96	89-103
$AUC_{inf}/dose$ [(ng•day/mL)/mg]	-	5545 5704 (26.5)	5742 6091 (33.4)	97	89-105
$C_{max}/dose$ [(ng/mL)/mg]	-	143 147 (27.1)	143 151 (33.9)	100	92-108
T_{max} [day]	-	7* (2-14)*	7* (2-21)*	-	-

* median (range)

AUC_{last} : area under the serum concentration time curve (AUC) from time zero to the time of the last quantifiable concentration; AUC_{inf} : AUC from time zero to infinity; C_{max} : Observed maximum serum concentration;

T_{max} : time to maximum serum concentration after administration.

The terminal elimination half-life, $T_{1/2}$, was as follows (arithmetic mean (CV%)):

non-aged solution: 23.1 days (22.3) for 150 mg dose and 21.2 days (22.2) for 300 mg dose;

aged solution: 22.2 days (19.1) for 150 mg dose and 20.3 days (17.6) for 300 mg dose;

lyophilized powder: 22.6 days (20.8) for 150 mg dose and 20.5 days (24.0) for 300 mg dose.

DETAILED PHARMACOLOGY

ANIMAL PHARMACOLOGY

Omalizumab is characterized as a non-anaphylactogenic antibody because of the following: Epitope mapping studies demonstrated that omalizumab and MaE11 bind the same site on IgE as FcεRI; omalizumab did not recognize IgE on FcεRI-bearing cells; omalizumab did not induce spontaneous histamine release from IgE-loaded human basophils.

With the exception of one possibly drug-related anaphylactoid reaction in a patient, omalizumab administration did not result in anaphylaxis in nonhuman primates or in the clinic.

Characterization of omalizumab:IgE complexes demonstrated that: omalizumab forms complexes with IgE that are predominantly heterotrimers or hexamers with a maximum molecular weight of 1 million; the size and composition of the complex is dependent on the molar ratio of the 2 molecules. Complexes formed *in vivo* were similar to those studied *in vitro*. Neither omalizumab nor omalizumab:IgE complexes bound C1q or generated C3a. omalizumab did not mediate complement-dependent cytotoxicity. No evidence of immune complex disease has been observed in the nonclinical or clinical setting after administration of omalizumab.

Binding studies showed that omalizumab bound human IgE with high affinity. omalizumab bound cynomolgus IgE with similar affinity, supporting the selection of this species for further nonclinical pharmacology and toxicology studies.

Characterization of omalizumab as an inhibitor of IgE:FcεRI interaction demonstrated that omalizumab competitively inhibited IgE:FcεRI interaction, consistent with the epitope mapping of omalizumab and FcεRI to the same site on IgE. omalizumab was able to trap IgE as it dissociated from the FcεRI *in vitro* and may, therefore, aid in off-loading IgE from receptors *in vivo*.

Omalizumab was able to suppress very high levels of total free IgE to 25 ng/mL, the therapeutic target identified in clinical studies, at molar ratios of omalizumab:IgE ranging from 16 to 21. omalizumab inhibited histamine release from cells sensitized with ragweed-specific IgE. omalizumab also blocked histamine release and contraction of human and cynomolgus monkey lung strips after passive sensitization with ragweed-specific IgE.

Omalizumab reduced high-affinity receptor expression *in vitro* and *in vivo* by decreasing free IgE. Treatment with omalizumab reduced FcεRI on human basophils such that histamine release was reduced or eliminated in response to antigen challenge.

Omalizumab inhibited IgE synthesis *in vitro*; however, no significant effect on IgE synthesis was observed clinically. There are no data to suggest that administration of omalizumab and the resultant decreased levels of free IgE cause a positive feedback signal and increased synthesis of IgE when omalizumab therapy is withdrawn.

Omalizumab demonstrated pharmacological activity in a nonhuman primate model of hypersensitivity to ragweed. Skin test reactivity was reduced in cynomolgus monkeys sensitized to ragweed after administration of omalizumab.

TOXICOLOGY

A comprehensive series of toxicology studies was conducted to establish a nonclinical safety profile.

Since omalizumab does not bind to mouse IgE, and IgE is not normally found in mouse serum at significant levels, the mouse was selected to evaluate high dose nonspecific toxicity. The cynomolgus monkey was considered to be a relevant species for preclinical toxicity evaluations because omalizumab has nearly equivalent affinity for IgE purified from cynomolgus monkey serum (0.19 nM) as for human IgE (0.06 nM). In addition, the monkey is considered an exaggerated model of atopy compared with humans as baseline serum concentrations of IgE were generally greater in cynomolgus monkeys than normally observed in the atopic individuals enrolled in our clinical trials. Consequently, the monkeys in these studies had much higher levels of omalizumab:IgE complexes than would be expected in typical humans with asthma.

This comprehensive series of acute and multiple-dose toxicity studies demonstrated that omalizumab produced no adverse effects at clinically relevant serum concentrations of drug. At suprapharmacologic serum concentrations, dose levels of up to 250 mg/kg (more than 14-fold-the highest recommended clinical dose), omalizumab induced thrombocytopenia and effects secondary to thrombocytopenia. The serum concentration required to attain a 50% drop in platelets from baseline was roughly 3.7 to 20-fold higher than anticipated serum concentrations in adult and adolescent clinical patients receiving the highest dose of omalizumab. Juvenile monkeys were more sensitive to platelet effects than adult monkeys; the median trough concentration of omalizumab at steady-state in pediatric patients (<12 years of age) from studies 7 and 8 was between 2.2-fold (patients with baseline IgE levels >700 IU/mL) and 9.6-fold (patients with baseline IgE levels of 30-200 IU/mL) lower than the threshold concentration in juvenile monkeys associated with a 50% drop in platelets. Other than the platelet-associated effects, there were no other clinical or pathological signs of toxicity. In particular, no clinical or histopathological evidence of renal toxicity nor evidence of a systemic anaphylactic response due to mast cell degranulation were observed in any of the studies, despite the presence of omalizumab:IgE complexes in all of the monkey studies.

Omalizumab has been shown to evoke a low level immune response to heterologous protein in some cynomolgus monkeys. This is not unexpected based on administration of a heterologous protein. Special toxicity studies demonstrated safety in a cynomolgus monkey model challenged with ragweed allergen, no evidence of in vitro tissue cross-reactivity with cynomolgus monkey and human tissues, no evidence of in vitro hemolysis of human and cynomolgus monkey erythrocytes or incompatibility with human and cynomolgus monkey serum and plasma, and no evidence of irritation in the rabbit. In addition, omalizumab was not mutagenic in the Ames test. No rodent carcinogenicity studies have been performed since omalizumab does not bind rodent IgE and the IgG structure of omalizumab does not raise any concerns relating to carcinogenic potential. Reproduction studies in cynomolgus monkeys have been conducted with omalizumab. Subcutaneous doses up to 75 mg/kg/week (approximately 10-fold the highest recommended clinical dose in mg/kg over a 4-week period) of omalizumab did not elicit maternal toxicity, embryotoxicity, or teratogenicity when administered throughout organogenesis and did not elicit adverse effects on fetal or neonatal growth when administered throughout late

gestation, delivery, and nursing. Although no clinically significant effects on platelets have been observed in patients, doses of omalizumab in excess of the clinical dose have been associated with age-dependent decreases in blood platelets in nonhuman primates, with a greater relative sensitivity in juvenile animals. In reproduction studies in cynomolgus monkeys, there was no clinical evidence of thrombocytopenia in neonatal monkeys from mothers treated with up to 75 mg/kg omalizumab; however, platelet counts were not measured in these offspring. The excretion of omalizumab in milk was evaluated in female cynomolgus monkeys receiving SC doses of 75 mg/kg/week. Neonatal serum levels of omalizumab after *in utero* exposure and 28 days of nursing were between 11% and 94% of the maternal serum level. Milk levels of omalizumab were 0.15% of the maternal serum concentration.

Acute Toxicity Studies

Study Type	Species/ Strain	No./Sex/ Group	Route of Admin. ^a	Dose (mg/kg)	Study Duration	Findings
Mouse/ single dose	Mouse Crl:CD-1 ⁷ (ICR) BR VAF/Plus ⁷	5/M 5/F	IV	0	2 weeks	No test material-related clinical or pathological signs of toxicity were observed. With the exception of 2 animals in the mid-dose group, there was no evidence of antibody formation
				1		
				10		
				100		
Monkey/ single dose	Cynomolgus monkey	2/M 2/F	IV	0	2 weeks	No test material-related clinical signs of toxicity were observed. Free IgE and total IgE serum concentrations at baseline and Day 15 were similar for control and low-dose. From baseline to Day 15, the total serum IgE in the mid- and high-dose groups increased in all animals, whereas the free serum IgE either decreased or did not increase. There was no evidence of antibody formation. rhuMAb E25 at a dose of 1 µg did not elicit an allergic response when injected intradermally on Day 15.
				0.5		
				5		
				50		
Monkey/ single dose	Cynomolgus monkey	2/M 2/F	SC	0	2 weeks	No test material-related clinical signs of toxicity were observed. Free IgE and total IgE serum concentrations at baseline and Day 15 were similar for control and low-dose groups. From baseline to Day 15, the total serum IgE in the mid- and high-dose increased in all animals, whereas the free serum IgE either decreased or did not increase. There was no evidence of antibody formation. rhuMAb E25 at a dose of 1 µg did not elicit an allergic response when injected intradermally on Day 15.
				0.5		
				5		
				50		
Monkey/ single dose (bridging)	Cynomolgus monkey	2/M 2/F	IV	0	2 weeks ^b	A single intravenous dose of rhuMAb E25 up to 200 mg/kg or a single subcutaneous dose of rhuMAb E25 up to 50 mg/kg was well tolerated and produced no adverse effects in cynomolgus monkeys. Serum total IgE concentrations increased an average of 4-fold above baseline and free IgE decreased following rhuMAb E25 administration. Two animals in the high dose IV group had antibody titers to rhuMAb E25 Fab and one animal given SC rhuMAb E25 had a detectable anti-Fab titer.
				50		
			SC	200		
				50		

^a IV = Intravenous, SC = Subcutaneous.

^b In addition to the 14 day postdose observation period; samples were collected 61 days postdose, to further evaluate antibody production to omalizumab.

Repeated-Dose Toxicity Studies

Study Type	Species/ Strain	No./Sex/ Group	Route of Admin. ^a	Dose (mg/kg)	Study Duration	Findings
Mouse/ Multi-dose 4 Weeks	Mouse Crl:CD-1 ⁷ (ICR) BR/ VAF Plus ⁷	15-25/M 15-25/F	IV	0 1 10 50	4 weeks dosing/ 4 weeks post obs	No test material-related clinical or pathological signs of toxicity were observed. There was no evidence of antibody formation to rhuMAb E25.
Monkey Multi-dose 4 Weeks	Cynomolgus monkey	1-5/M 1-5/F	IV SC	0 0.1 1 5 mg/kg 3 times per week	4 weeks dosing/ 4 weeks post obs	No test material-related clinical or pathological signs of toxicity were observed. rhuMAb E25 was eliminated slowly from serum; PK was linear. There was no significant difference in total serum IgE in low-dose as compared to control. Total serum IgE increased following treatment with mid- and high-doses of rhuMAb E25. Free serum IgE decreased or remained at baseline in control and low-dose animals, and decreased to undetectable amounts in mid- and high-dose animals. There was a low incidence (3/20 evaluated) of antibody formation to rhuMAb E25. rhuMAb E25 at a dose of 1 µg did not elicit an allergic response when injected intradermally at the end of the treatment period and at the end of the recovery period.
Monkey/ Multi-dose 6 months	Cynomolgus monkey	1-5/M 1-5/F	IV SC	0 0.1 1 5 mg/kg 3 times per week	26	Based on the results of this study, subcutaneous and intravenous bolus injections of rhuMAb E25 up to 5.0 mg/kg three times/week were well tolerated and produced no systemic adverse effects when administered to cynomolgus monkeys for approximately 6 months followed by an 8-week recovery. Serum total IgE concentrations increased approximately 6-fold compared to baseline in the high dose groups. There was a low incidence of antibody formation against rhuMAb E25.

^a IV = Intravenous, SC = Subcutaneous.

Repeated-Dose Toxicity Studies (continued)

Study Type	Species/ Strain	No./Sex/ Group	Route of Admin.^a	Dose (mg/kg)	Study Duration	Findings
Monkey/ Multi-dose 6-months	Juvenile Cynomolgus monkey	4-6/M 4-6/F	SC	0 50 250 mg/kg/ week	26 weeks dosing/ 26 weeks recovery	Significant and sustained decreases in peripheral blood platelets were observed in juvenile cynomolgus monkeys following treatment with omalizumab. Effects were highly correlated to dose and serum concentration. Other than suppression of platelet levels and changes secondary to thrombocytopenia, no test-article-related effects were evident.
Monkey Multi-dose Up to 6-months	Juvenile and adult Cynomolgus monkeys	3-6/M 3-6/F	SC	0 15 30 50 100 250 mg/kg/ week	4, 6, or 26 weeks dosing/ 13 weeks recovery	Significant and sustained decreases in peripheral blood platelets were observed in cynomolgus monkeys following treatment with omalizumab. Effects were correlated to dose and serum concentration. The time of onset was earlier and the magnitude of severity was greater in juveniles than in adults.
Monkey Multi-dose 4-weeks with IVIG	Juvenile Cynomolgus monkey	3F	SC	0 100 100 with IVIG infusion on days 17 and 18	4 weeks dosing	Omalizumab at doses of 100mg/kg/week induced a moderate decrease in peripheral blood platelets in 3 of 6 cynomolgus monkeys that could be reversed by administration of IVIG (intravenous immunoglobulin). Given the inhibitory effect of IVIG on Fc-mediated clearance of platelets, it is likely that platelet phagocytosis plays a role in omalizumab-induced thrombocytopenia.
Monkey Multi-dose 12-weeks	Adult African green, cynomolgus, rhesus	3F	SC	0 100 250 mg/kg/ week	12-weeks dosing/ 13 weeks recovery	Significant and sustained decreases in peripheral blood platelets were observed in cynomolgus monkeys following treatment with omalizumab. The magnitude and persistence of decreased platelets was less pronounced in the rhesus and African green monkeys.

^a SC = Subcutaneous.

Repeated-Dose Toxicity Studies (continued)

Study Type	Species/ Strain	No./Sex/ Group	Route of Admin. ^a	Dose (mg/kg)	Study Duration	Findings
Multi-dose Up to 4-weeks	Chimpanzee	3M/3F	SC	250 mg/kg/ week	Up to 4-weeks dosing/ 13-weeks recovery	Omalizumab induces significant but reversible decreases in peripheral blood platelet counts at a dose of 250 mg/kg/week in the chimpanzee.

^a SC = Subcutaneous.

Reproductive Toxicity Studies

Study Type	Species/ Strain	No./Sex/ Group	Route of Admin. ^a	Dose (mg/kg)	Study Duration	Findings
Male Fertility Study	Cynomolgus monkey	10/M	SC	0 3 15 75	6 weeks dosing/ 2 weeks post obs	Subcutaneous administration of rhuMAb E25, at doses up to and including 75 mg/kg, was well tolerated and did not elicit reproductive toxicity in male cynomolgus monkey.
Female fertility study	Cynomolgus monkey	10/F	SC	0 3 15 75	4-5 months dosing	Subcutaneous administration of rhuMAb E25, at doses up to and including 75 mg/kg, was well tolerated and did not inhibit reproductive capacity, including implantation in female cynomolgus monkey.
Embryo- toxicity Terato- genicity	Cynomolgus monkey	12/F	SC	0 3 15 75	30 days dosing/ 50 days post obs	Subcutaneous administration of rhuMAb E25, at doses up to and including 75 mg/kg, was well tolerated and did not elicit maternal toxicity, embryotoxicity or teratogenicity when administered throughout organogenesis (gestation days 20-50) in the cynomolgus monkey.

^a SC = Subcutaneous.

Reproductive Toxicity Studies (continued)

Study Type	Species/ Strain	No./Sex/ Group	Route of Admin. ^a	Dose (mg/kg)	Study Duration	Findings
Late gestation Study	Cynomolgus monkey	8/F	SC	0 75	30-70 days dosing	Subcutaneous administration of rhuMAb E25, at doses of 75 mg/kg, was well tolerated and did not elicit adverse effects on fetal growth at late gestation (gestation days 120 - delivery), delivery, nursing, or neonatal growth in the cynomolgus monkey.

^a SC = Subcutaneous.

Special Toxicity Studies

Study Type	Species/ Strain	No./ Sex/ Group	Route of Admin. ^a	Dose (mg/kg)	Study Duration	Findings
Pilot evaluation in monkeys exposed to ragweed allergen	Cynomolgus monkeys	6/F	IV, SC	5 10 50	35 weeks	Skin sensitivity to ragweed was elicited in all animals after three challenge doses. Intradermal skin sensitivity was diminished after treatment with rhuMAb E25 and reactivity to ragweed returned approximately 55 days after rhuMAb E25 treatment was terminated. Subcutaneous doses of rhuMAb E25 up to 10 mg/kg and intravenous doses up to 50 mg/kg were well tolerated and produced no adverse effects in ragweed allergen sensitized cynomolgus monkeys.
Skin reactivity to ragweed extract/pilot evaluation	Cynomolgus monkey	2/F	ID (ragweed extract) IV (Evans Blue dye)	0.001, 0.01, 0.1, 1.0 µg	31 minutes	Based on the results of a wheal/flare allergy test aided with the use of Evans Blue, an allergic response was not elicited to ragweed when injected intradermally in naïve cynomolgus monkeys. A positive histamine response was elicited.
Tissue specificity analysis	Frozen cynomolgus monkey tissues	–	–	49 (rhuMA b E25) 22.5 (MaE11)	–	Specific staining was observed with both rhuMAb E25 and MaE11 in germinal centers of a lymph node and Peyer's patch of the large intestine of the female but not the male monkey. The reaction was considered to represent synthesis of IgE by lymphoid cells. Specific staining of other tissues was not observed.

^a IV = Intravenous, SC = Subcutaneous, ID = Intradermal.

Special Toxicity Studies (continued)

Study Type	Species/ Strain	No./ Sex/ Group	Route of Admin.^a	Dose (mg/kg)	Study Duration	Findings
Tissue specificity analysis	Frozen human tissues	–	–	49 (rhuMAb E25) 22.5 (MaE11)	–	Specific staining of the tissues was not observed with rhuMAb E25 but was seen with MaE11. With the latter, reactivity was seen in lymphoid cells of 1/3 spleens. The reaction was considered to represent synthesis of IgE by lymphoid cells of that individual. Specific staining of other tissues was not observed.
In vitro hemolytic potential and blood compatibility	Human and cynomolgus monkey-whole blood, serum, plasma	–	–	0, 5	–	Results indicate that rhuMAb E25 and rhuMAb E25 Vehicle did not cause hemolysis of cynomolgus monkey or human erythrocytes and were compatible with cynomolgus monkey or human serum and plasma.
In vitro hemolytic potential and blood compatibility	Human and cynomolgus monkey - whole blood, serum, and plasma	–	–	0, 40	–	Results indicate that rhuMAb E25 (12,000 L; 40 mg/mL in formulation) and rhuMAb E25 (12,000 L) Vehicle did not cause hemolysis of of cynomolgus monkey or human erythrocytes and were compatible with cynomolgus monkey or human serum and plasma.
In vitro hemolytic potential and blood compatibility	Human whole blood, serum, and plasma	–	–	0, 100	–	Results indicate that rhuMAb E25 (lyophilized formulation) at a concentration of 100 mg/mL, and rhuMAb E25 Vehicle did not cause hemolysis of human erythrocytes and were compatible with human serum and plasma.
Acute local tolerance	Rabbit Hra: (NZW) SPF	9/M	IV SC ID	0, 5	1 week	No clinical observations or histopathological findings indicative of local irritation were attributed to the test material or vehicle.

^a IV = Intravenous, SC = Subcutaneous, ID = Intradermal

Special Toxicity Studies (continued)

Study Type	Species/ Strain	No./ Sex/ Group	Route of Admin.^a	Dose (mg/kg)	Study Duration	Findings
Multiple dose SC single dose intravenous rabbit tolerance	Rabbit Hra: (NZW) SPF	15/M	IV, SC	0, 5, 20, 40	21 Days	Based on the results of this study, 14 daily subcutaneous injections (1 mL volume) of 5 mg/mL rhuMAb E25 (400 L) or 20 and 40 mg/mL of rhuMAb E25 (12,000 L) were associated with a slightly higher level of subacute inflammation at the injection sites than similar treatment in animals given the vehicles or saline. This inflammation was typically associated with an increased number of eosinophils. Because clinical signs of irritation were not evident beyond Day 12 and because the microscopic findings were not indicative of functional tissue damage, these findings were not considered toxicologically significant. There were no meaningful differences in incidence or severity of local irritation from rhuMAb E25 (12,000 L) when compared to rhuMAb E25 (400 L). There was no macroscopic or microscopic evidence of irritation following a single intravenous injection of 20 mg/mL of rhuMAb E25 (12,000 L) to rabbits.
Acute local tolerance	Rabbit Hra: (NZW) SPF	9/M	IV, SC	0, 100	1 week	Based on the results of this study, administration of rhuMAb E25 given as a single intravenous bolus injection and a single subcutaneous injection following reconstitution with 1.1% benzyl alcohol to a concentration of 100 mg/mL was well tolerated in rabbits and produced no obvious local irritation attributable to the test material.
Acute local tolerance	Rabbit Hra:(NZW)	3/F	SC	0, 125	1 week	Administration of rhuMAb E25 placebo and rhuMAb E25 as a single, 125 mg/mL subcutaneous bolus injection had no obvious irritating effect. Reconstituting the test material and placebo in saline, as opposed to sterile Water for Injection (SWFI) did not produce any differences in redness or swelling at the injection sites. Based on the results of this study, administration of rhuMAb E25 placebo and rhuMAb E25 given as a single subcutaneous bolus injection following reconstitution with either SWFI or saline to a concentration of 125 mg/mL was well tolerated in rabbits and produced no treatment-related signs of local irritation.

^a IV= Intravenous,

SC=Subcutaneous,

ID= Intraderm

REFERENCES

1. Presta LG, Lahr SJ, Shields RL, Porter JP, Gorman CM, Fendly BM, Jardieu PM. Humanization of an antibody directed against IgE. *J Immunol* 1993; 151:2623-32.
2. Heusser C, Jardieu P. Therapeutic potential of anti-IgE antibodies. *Cur Opin Immunol* 1997; 9:805-13.
3. MacGlashan DW Jr, Bochner BS, Adelman DC, Jardieu PM, Togias A, McKenzie-White J, et al. Down-regulations of FcεRI expression on human basophils during in vivo treatment of atopic patients with anti-IgE antibody. *J Immunol* 1997; 158:1438-45.
4. Saini SS, MacGlashan DW Jr, Sterbinsky SA, Togias A, Adelman DC, Lichtenstein LM, et al. Down-regulation of human basophil IgE and FcεRIα surface densities and mediator release by anti-IgE-infusions is reversible in vitro and in vivo. *J Immunol* 1999; 162:5624-30.
5. Liu J, Lester P, Builder S, Shire SJ. Characterization of complex formation by humanized anti-IgE monoclonal antibody and monoclonal human IgE. *Biochemistry* 1995; 34:10474-82.
6. Fox JA, Reitz B, Hagler K, Hsei V, Keller G, Ryan A. Et al. Pharmacokinetics and clearance mechanisms of anti-IgE:IgE monoclonal and polyclonal complexes [abstract], *Pharm Res* 1997;14:S217.
7. National Institute of Health. Guidelines for the diagnosis and management of asthma. Bethesda (MD); National Institute of Health, National Heart, Lung and Blood Institute; 1997 Jul., Report No. NIH Publication No. 97-4051.
8. Juniper EF, Guyatt GH, Ferrie PJ, Griffith LE. Measuring quality of life in asthma. *AM Rev Respir Dis*, 1993; 147:832-38.
9. Juniper EF, Guyatt GH, Willan A, Griffith LE. Determining a minimal important change in a disease-specific quality of life questionnaire. *J Clin Epidemiol* 1994; 47:81-7.
10. Juniper EF, Guyatt GH, Feeny DH, Ferrie PJ, Griffith LE, Townsend M. Measuring quality of life in children and asthma. *Quality of Life Research* 1996; 5:35-46.
11. Juniper EF, Guyatt GH. Development and testing of a new measure of health status for clinical trials in rhinoconjunctivitis. *Clin Exp Allergy* 1991; 21:77-83.
12. Roitt IM. Roitt=s essential immunology. In: *Antibodies*, Chapter 3, Ninth Edition. Malden (MA): Blackwell Science Inc., 1997;3:43.
13. Ayres JG, Higgins B, Chilvers ER, Ayre G, Blogg M, Fox H. Efficacy and tolerability of anti-immunoglobulin E therapy with omalizumab in patients with poorly controlled (moderate-to-severe) allergic asthma. *Allergy* 2004; 59:701-708.

14. Buhl R, Solèr M, Matz J, Townley R, O'Brien J, Noga O, Champaign K, Fox H, Thirlwell J, Della Cioppa G. Omalizumab provides long-term control in patients with moderate-to-severe allergic asthma. *J Eur Respir* 2002; 20: 73-78.
15. Holgate ST, Chuchalin AG, Hébert J, Lötvalls J, Persson GB, Chung KF, Bousquet J, Kerstjens HA, Fox H, Thirlwell J, Della Cioppa G. Efficacy and safety of a recombinant anti-immunoglobulin E antibody (omalizumab) in severe allergic asthma. *Clin Exp Allergy* 2004; 34: 632-638.
16. Holgate S, Bousquet J, Wenzel S, Fox H, Lui J, Castellsague J. Efficacy of omalizumab and anti-immunoglobulin E antibody in patients with allergic asthma at high risk of serious asthma-related morbidity and mortality. *Cur Med Research and Opinion* 2001; 17: 233-240.
17. Milgrom H, Berger W, Nayak A, Gupta N, Pollard S, McAlary M, Fowler-Taylor A, Rohane P. Treatment of childhood asthma with anti-immunoglobulin E antibody (omalizumab). *Pediatrics* 2001;108:1-10.
18. Quentin-Lanier B, Corren J, Lumry W, Liu J, Fowler-Taylor A, Gupta N. Omalizumab is effective in the long-term control of severe allergic asthma. *Ann Allergy Asthma Immunol* 2003; 91: 154-159.
19. Vignola AM, Humbert M, Bousquet J, Boulet LP, Hedgcock S, Blogg M, Fox H, Surrey K. Efficacy and tolerability of anti-immunoglobulin E therapy with omalizumab in patients with concomitant allergic asthma and persistent allergic rhinitis: SOLAR. *Allergy* 2004; 59: 709-717.
20. Busse W, Corren J, Lanier BQ, McAlary M, Fowler-Taylor A, Della Cioppa G, van As, A, Gupta, N. Omalizumab, anti-IgE recombinant humanized monoclonal antibody, for the treatment of severe allergic asthma. *J Allergy Clin Immunol*. 2001;108(2):184-190.
21. Solèr M, Matz J, Townley, R, Buhl R, O'Brien, J, Fox H, Thirlwell J, Gupta N, Della Chioppa G. The anti-IgE antibody omalizumab reduces exacerbations and steroid requirement in allergic asthmatics. *Eur Respir J*. 2001;18:254-261.
22. Kaplan A, Ledford D, Ashby M, Canvin J, Zazzali JL, Conner E, Veith J, Kamath N, Staubach P, Jakob T, Stirling RG, Kuna P, Berger W, Maurer M, Rosén K. Omalizumab in patients with symptomatic chronic idiopathic/spontaneous urticaria despite standard combination therapy. *J Allergy Clin Immunol*. 2013 Jul;132(1):101-9. (GLACIAL)
23. Maurer M, Rosén K, Hsieh HJ, Saini S, Grattan C, Giménez-Arnau A, Agarwal S, Doyle R, Canvin J, Kaplan A, Casale T. Omalizumab for the treatment of chronic idiopathic or spontaneous urticaria. *N Engl J Med*. 2013 Mar 7;368(10):924-35. (ASTERIA II)
24. Maurer M, Altrichter S, Bieber T, Biedermann T, Bräutigam M, Seyfried S, Brehler R, Grabbe J, Hunzelmann N, Jakob T, Jung A, Kleine-Tebbe J, Mempel M, Meurer M, Reich K, Ruëff F, Schäkel K, Sengupta K, Sieder C, Simon JC, Wedi B, Zuberbier T,

- Mahler V, Staubach P. Efficacy and safety of omalizumab in patients with chronic urticaria who exhibit IgE against thyroperoxidase. *J Allergy Clin Immunol*. 2011 Jul;128(1):202-209.e5. (X-QUISITE)
25. Saini S, Rosen KE, Hsieh HJ, Wong DA, Conner E, Kaplan A, Spector S, Maurer M. A randomized, placebo-controlled, dose-ranging study of single-dose omalizumab in patients with H1-antihistamine-refractory chronic idiopathic urticaria. *J Allergy Clin Immunol*. 2011 Sep;128(3):567-73.e1. (MYSTIQUE)
26. Saini SS, Bindslev-Jensen C, Maurer M, Grob JJ, Baskan EB, Bradley MS, Canvin J, Rahmaoui A, Georgiou P, Alpan O, Spector S, Rosén K. Efficacy and Safety of Omalizumab in Patients with Chronic Idiopathic/Spontaneous Urticaria Who Remain Symptomatic on H1-Antihistamines: A Randomized, Placebo-Controlled Study. *J Invest Dermatol*. 2014 Jul 21. doi: 10.1038/jid.2014.306. (ASTERIA I)
27. Zuberbier T, Aberer W, Asero R, Bindslev-Jensen C, Brzoza Z, Canonica GW, Church MK, Ensina LF, Giménez-Arnau A, Godse K, Gonçalo M, Grattan C, Hebert J, Hide M, Kaplan A, Kapp A, Abdul Latiff AH, Mathelier-Fusade P, Metz M, Nast A, Saini SS, Sánchez-Borges M, Schmid-Grendelmeier P, Simons FE, Staubach P, Sussman G, Toubi E, Vena GA, Wedi B, Zhu XJ, Maurer M. The EAACI/GA(2) LEN/EDF/WAO Guideline for the definition, classification, diagnosis, and management of urticaria: the 2013 revision and update. *Allergy*. 2014 Jul;69(7):868-87. doi: 10.1111/all.12313. Epub 2014 Apr 30.

PART III: CONSUMER INFORMATION

XOLAIR®
(omalizumab)

This leaflet is part III of a three-part "Product Monograph" published when XOLAIR was approved for sale in Canada and is designed specifically for Consumers. This leaflet is a summary and will not tell you everything about XOLAIR. Contact your doctor or pharmacist if you have any questions about the drug.

ABOUT THIS MEDICATION

Read all of this leaflet carefully before you are given this medicine.

- Keep this leaflet. You may need to read it again.
- If you have further questions, please ask your doctor, nurse or pharmacist.

What the medication is used for:AsthmaAdults and adolescents 12 years of age and older:

XOLAIR (omalizumab) is a prescription medicine that has been shown to significantly decrease the incidence of asthma exacerbations and improve control of asthma symptoms in people who:

- Are 12 years of age and above
- Have moderate to severe persistent asthma. This means they have 1 or more of the following:
 - Asthma symptoms every day
 - Daily need for a rescue inhaler
 - 2 or more asthma attacks a week
 - 1 or more nights a week waking up with asthma symptoms
 - below-normal reading (less than 80%) from a tool called a peak flow meter, which measures how well the lungs work
- Have asthma that is triggered by year-round allergens in the air, which is confirmed by a doctor using a simple skin or blood test. This is known as allergic asthma
- Continue to have asthma symptoms even though they are taking inhaled steroids

Children 6 to less than 12 years of age:

XOLAIR, used as add-on therapy, has been shown to significantly decrease the rate of asthma exacerbations for children who are 6 to less than 12 years of age with moderate to severe persistent allergic asthma who continue to have asthma symptoms even though they are taking inhaled steroids and have a documented history of asthma exacerbation.

Chronic Rhinosinusitis with Nasal Polyps (CRSwNP)

XOLAIR is used to treat adults (18 years of age and older) with chronic rhinosinusitis with nasal polyps (CRSwNP) whose disease is not well controlled with their current CRSwNP medicines. XOLAIR helps reduce the size of the polyps and

improves symptoms caused by CRSwNP including nasal congestion, loss of sense of smell, post-nasal drip and runny nose.

Chronic Idiopathic Urticaria (CIU)

XOLAIR (omalizumab) is a prescription medicine to treat Chronic Idiopathic Urticaria (CIU) in adults and adolescents (12 years of age and older) whose symptoms are not well controlled with antihistamines. XOLAIR provides relief of CIU symptoms such as skin itch and hives.

What it does:What is allergic asthma?

Allergic asthma is how doctors describe a particular type of asthma. In people with this common condition, certain types of allergens can trigger asthma attacks and symptoms, such as coughing, wheezing, and shortness of breath.

You probably know about many of the things that can trigger your asthma. Cat or dog dander, dust mites, and cockroaches are common examples of year-round allergens. What you may not know is how something as simple as visiting a friend who has a pet can lead to an asthma attack. The reason allergens can trigger asthma attacks is due, in part, to a body chemical called IgE.

What is Chronic Idiopathic Urticaria (CIU)

Chronic Idiopathic Urticaria (CIU) is a skin disease whose symptoms include itching and hives for at least 6 weeks. Persistent symptoms may be daily or episodic. Some people with CIU may also have swelling of the skin.

What is IgE?

IgE is short for immunoglobulin E. This substance, which occurs naturally in your body in small amounts, plays an important role in allergic asthma and CIU.

If you have allergic asthma, your body makes more IgE when you breathe in an allergen that triggers your asthma. This can cause a series of chemical reactions known as the "allergic-inflammatory process in allergic asthma". It can result in 2 things:

- The muscles that surround your airways begin to tighten. This is known as *constriction of the airways*
- Your airways become irritated and swell up. This is known as *inflammation of the airways*

Together, constriction and inflammation of the airways make it harder for you to breathe. This can lead to an asthma attack, also known as exacerbation.

What is XOLAIR?

XOLAIR is supplied as a powder in a small glass vial. The powder is dissolved in sterile water for injection before it is injected. Each vial delivers 150 mg of omalizumab. XOLAIR is also available as a ready to use solution in a pre-filled syringe. The syringe is available in both 75 mg and 150 mg of omalizumab.

Asthma and Chronic Rhinosinusitis with Nasal Polyps (CRSwNP)

XOLAIR blocks a substance called immunoglobulin E (also known simply as IgE) which is produced by your body. IgE contributes to a type of inflammation that plays a significant role in causing asthma and CRSwNP. Your doctor will measure the amount of IgE with a blood test and determine your body weight before starting the treatment with XOLAIR. By blocking IgE, XOLAIR helps stop the allergic-inflammatory process in allergic asthma.

Adding XOLAIR injections to treatment with inhaled steroids has been clinically proven to help reduce the number of asthma attacks. XOLAIR has not been proven to work in other allergic conditions.

XOLAIR is not a rescue medicine and should not be used to treat sudden asthma attacks. It is not a substitute for the medicines you are already taking.

Chronic Idiopathic Urticaria (CIU)

XOLAIR blocks a substance called immunoglobulin E (also known simply as IgE) which is produced by your body. By binding to IgE, XOLAIR reduces the activation of certain cells in your body and the release of histamine and other chemicals. This helps reduce symptoms of CIU, including itching and hives.

When it should not be used:

You should not be given XOLAIR:

If you are hypersensitive (allergic) to omalizumab or any of the other ingredients of XOLAIR (see below), or if you have ever had an allergic reaction to a XOLAIR injection.

If you ever had an allergic reaction to latex (information specific to the needle cap of the pre-filled syringe).

Use in children

Allergic asthma: XOLAIR is not indicated for children below 6 years of age

Chronic Rhinosinusitis with Nasal Polyps (CRSwNP):

XOLAIR is not indicated for children below 18 years of age.

Chronic idiopathic urticaria (CIU): XOLAIR is not indicated for children below 12 years of age

Pregnancy

Ask your doctor, nurse or pharmacist for advice before taking any medicine.

Before starting treatment with XOLAIR, tell your doctor if you are pregnant or think that you may be pregnant. Your doctor will discuss with you the benefits and potential risks of being given this medicine during pregnancy. Tell your doctor straight away if you become pregnant while being treated with XOLAIR.

Breast-feeding

Ask your doctor, nurse or pharmacist for advice before being given any medicine.

Tell your doctor if you are breast-feeding. It is not known whether omalizumab, the active substance of XOLAIR, passes into breast milk or in what ways this could affect the baby. Your doctor will discuss with you the benefits and potential risks of being given this medicine while you are breast-feeding.

Fertility

There are no human fertility data for XOLAIR.

Driving and using machines

You may experience dizziness, sleepiness or fatigue after receiving XOLAIR, in which case you should not drive or use machines.

What the medicinal ingredient is:

omalizumab

What the nonmedicinal ingredients are:

XOLAIR 75 mg and 150 mg solution for injection in pre-filled syringe: L-arginine hydrochloride, L-histidine hydrochloride, L histidine, polysorbate 20, water for injection.

XOLAIR 150 mg powder and solvent for solution for injection: histidine, histidine hydrochloride monohydrate, polysorbate 20 and sucrose

What dosage forms it comes in:

XOLAIR 75 mg and 150 mg solution for injection in pre-filled syringe and sterile powder for reconstitution, 150 mg vial (125 mg/mL after reconstitution)

WARNINGS AND PRECAUTIONS

1- A severe allergic reaction called anaphylaxis can happen in some patients after receiving XOLAIR. Anaphylaxis is a life-threatening condition. Signs and symptoms of anaphylaxis include difficulty breathing, light-headedness, rash, itching, and swelling of the tongue and throat (see SIDE EFFECTS AND WHAT TO DO ABOUT THEM).

Anaphylaxis from XOLAIR can happen as early as after the first injection or hours later, and/or after any XOLAIR injection. Your doctor, or nurse should watch you for some time for signs and symptoms of anaphylaxis after injecting XOLAIR. If you have any of the signs or symptoms of anaphylaxis, tell your doctor or nurse immediately, and get emergency medical treatment right away.

Your doctor or nurse should instruct you about starting emergency medical treatment and getting further medical care if you have any signs or symptoms of anaphylaxis.

2- Weakness or paralysis of limbs or face, loss of sensation, difficulty speaking or understanding, transient loss of vision in one eye could be symptoms of a transient ischemic attack or stroke. Seek immediate medical attention if you experience any such symptoms.

BEFORE you use XOLAIR, talk to your doctor or

pharmacist if you have:

- Hypersensitivity reaction to any drug (Warnings and Precautions)
- Any other known hypersensitivity (Warnings and Precautions)
- Any allergies to this drug or its ingredients or components of the container (Contraindications)
- If you ever had an allergic reaction to latex (information specific to the needle cap of the pre-filled syringe).

Parasite infections

If you are living in a region where parasite infections are frequent or traveling to such a region, please tell your doctor. XOLAIR may weaken your resistance to such infections.

If you are taking a treatment against parasite infection, please tell your doctor. XOLAIR may reduce the efficacy of your treatment.

INTERACTIONS WITH THIS MEDICATION

Please inform your doctor or nurse if you are taking or have recently taken any other medicines, even those not prescribed. Never suddenly stop taking, or change the dose of, your inhaled steroids or any other asthma medicine or of current medicine for CIU you are taking unless your doctor tells you to do so.

XOLAIR can be used together with other medicines for asthma and/or CRSwNP, as well as with H1 or H2 antihistamines and leukotriene receptor antagonists (LTRAs) for CIU, but it is still important to tell your doctor that you are taking them before you are given XOLAIR.

PROPER USE OF THIS MEDICATION

Your doctor or nurse will give you XOLAIR as an injection just under the skin.

A patient support program has been established to provide you with injection services. Contact your doctor to enroll.

Asthma

Based on your dose, your doctor will also tell you if you will need 1, 2, or 3 injections per dose. If you need more than 1 injection per dose, each will be given in a different area of your body.

You will receive 75, 150, 225 or 300 mg every four weeks, or 225, 300 or 375 mg every two weeks. You will probably need to continue taking your current asthma medicine during XOLAIR treatment but after 16 weeks you may be able to reduce or stop any other asthma medication that you are taking. Your doctor will discuss this with you. You should not reduce the dose of other asthma medication without first discussing with your doctor, even if you are feeling better.

Chronic Rhinosinusitis with Nasal Polyps (CRSwNP):

You will need 1 to 4 injections at a time. You will need the injections either every two weeks or every four weeks as

prescribed by your doctor.

Keep taking your current CRSwNP medicine during XOLAIR treatment. Do not stop taking any CRSwNP medications without talking to your doctor.

Chronic Idiopathic Urticaria (CIU)

XOLAIR 150 mg or 300 mg are administered subcutaneously every 4 weeks. The efficacy of XOLAIR in CIU patients depends on the quantity that is injected.

Usual dose:

Asthma and Chronic Rhinosinusitis with Nasal Polyps (CRSwNP):

XOLAIR is given once every 2 or 4 weeks. Your dose will be determined by your body weight and your IgE level, which your doctor will measure with a simple blood test. Based on your dose, your doctor will also tell you if you will need 1, 2, 3 or 4 injections per dose. If you need more than 1 injection, each will be given in a different place on your body.

Because it is a controller or *maintenance medicine*, you will receive XOLAIR on a regular schedule. It is important that you continue to receive your XOLAIR injections even when you are feeling well.

Chronic Idiopathic Urticaria (CIU)

You will be given 1 or 2 injections at a time every 4 weeks.

Continue taking your current medicine for CIU during XOLAIR treatment. Do not stop taking any medicine without talking to your doctor first.

Continue to use XOLAIR for as long as your doctor tells you to do so.

If you have questions about how long to receive XOLAIR, talk to your doctor or your pharmacist.

Overdose:

The maximum tolerated dose of XOLAIR has not been determined. Single intravenous doses up to 4000 mg have been administered to patients without evidence of dose-limiting toxicities. In case of overdosage, it is recommended that the patient be monitored for any signs or symptoms of adverse reactions or effects and appropriate symptomatic treatment instituted immediately.

If you think you have taken too much XOLAIR, contact your healthcare professional, hospital emergency department or regional Poison Control Centre immediately, even if there are no symptoms.

SIDE EFFECTS AND WHAT TO DO ABOUT THEM

As with all medicines, patients treated with XOLAIR can experience side effects.

The side effects caused by XOLAIR are usually mild. In clinical studies, they were about as common in people who were given XOLAIR as those who were given a placebo (or dummy) injection that did not contain omalizumab.

Some patients had a serious allergic reaction called anaphylaxis, occurring at an average of 2 out of 1000 patients (0.2%) or more. Should it happen, anaphylaxis quickly causes symptoms such as rash, itching, and swelling of the tongue and throat, which can make it hard to breathe and can be life threatening. If you think you are having an anaphylactic reaction, get medical attention right away. Please speak with your doctor about this information.

Take special care if you have a disorder where your own immune system attacks part of your own body (autoimmune disease).

A specific type of allergic reaction (serum sickness) has also been observed in patients treated with XOLAIR or similar products. Signs include joint pain, stiffness, rash, fever, swollen/enlarged lymph nodes and occur typically within one to five days after the injection. If you have such a reaction after taking XOLAIR, contact a doctor immediately.

In initial clinical studies in asthma, the number of observed malignancies was uncommon (<1%) in all studied patients who received XOLAIR or a placebo injection containing no medication, with 0.5% reported in patients receiving XOLAIR and 0.2% in patients receiving placebo injections. Results from a review of all the clinical trials now completed (double in size from the initial studies) and also results from a 5 year observational study found that XOLAIR was not associated with an increased risk of malignancy. Please discuss this information with your doctor.

The most common side effects reported in patients who received XOLAIR in clinical studies in asthma and CIU are listed below. This is not a complete list of all side effects reported with XOLAIR.

- Injection-site reaction (bruising, redness, warmth, burning, stinging, or other discomfort around the injection site)
- Viral infections
- Upper respiratory tract infection
- Sinusitis
- Headache
- Sore throat
- Urinary tract infection
- Feeling dizzy
- Abdominal pain

In children 6 to less than 12 years of age with asthma:

- Common cold symptoms
- Headache
- Fever
- Sore throat
- Pain or discomfort of your ear

- Nausea
- Vomiting
- Nose bleeding

Other less commonly observed side effects included pain, broken bones, leg pain, joint pain, muscle pain, joint swelling, and hair loss.

If you notice hives, skin rash, injection site reactions or any side effects not mentioned in this leaflet, please inform your doctor or nurse.

If you experience any of these, tell your doctor straight away.

SERIOUS SIDE EFFECTS, HOW OFTEN THEY HAPPEN AND WHAT TO DO ABOUT THEM				
Symptom / effect		Talk to your healthcare professional		Stop taking drug and get immediate medical help
		Only if severe	In all cases	
Rare	Sudden severe allergic reaction (sudden signs of allergy such as rash, itching or hives on the skin, swelling of the face, lips, tongue or other parts of the body, fast heartbeat, dizziness and light headedness, shortness of breath, wheezing or trouble breathing)			√
	Low blood platelet count with symptoms such as bleeding or bruising more easily than normal			√
	Joint appearance of some of the following symptoms: Pain, numbness or tingling in the arms and legs, lumps or raised patches in the skin, weakness and fatigue, loss of appetite and weight loss (signs of so-called "Churg-Strauss syndrome")			√
	Joint appearance of some of the following symptoms: Joint			√

SERIOUS SIDE EFFECTS, HOW OFTEN THEY HAPPEN AND WHAT TO DO ABOUT THEM

	<p>pain, stiffness, rash, fever, swollen/enlarged lymph nodes (signs of so-called serum-sickness). When it occurs this is usually between one to five days after injection</p>			
--	--	--	--	--

Canada Inc., at:
 1-800-363-8883
 or by contacting the patient support program at 1-866-996-5247

This leaflet was prepared by
 Novartis Pharmaceuticals Canada Inc.
 385 Bouchard Blvd.,
 Dorval, Quebec
 H9S 1A9

Last revised: July 19, 2021

XOLAIR is a registered trademark.

If you have a troublesome symptom or side effect that is not listed here or becomes bad enough to interfere with your daily activities, talk to your healthcare professional.

HOW TO STORE IT

XOLAIR is to be stored in a refrigerator (2°-8°C). Do not freeze. In order to protect from light, store in the original package. Any unused product or waste material should be disposed of in accordance with local requirements. Your doctor or nurse will know this. Keep this medicine out of the sight and reach of children. Do not shake.

Reporting Side Effects

You can help improve the safe use of health products for Canadians by reporting serious and unexpected side effects to Health Canada. Your report may help to identify new side effects and change the product safety information.

3 ways to report:

- Online at [MedEffect](#);
- By calling 1-866-234-2345 (toll-free);
- By completing a Consumer Side Effect Reporting Form and sending it by:
 - Fax to 1-866-678-6789 (toll-free), or
 - Mail to: Canada Vigilance Program Health Canada,
 Postal Locator 0701E
 Ottawa, ON
 K1A 0K9

Postage paid labels and the Consumer Side Effect Reporting Form are available at [MedEffect](#).

NOTE: Contact your health professional if you need information about how to manage your side effects. The Canada Vigilance Program does not provide medical advice.

MORE INFORMATION

This document plus the full product monograph, prepared for health professionals can be found at:
www.Novartis.ca
 or by contacting the sponsor, Novartis Pharmaceuticals